



# GfG Instrumentation

Worldwide Manufacturer of Gas Detection Solutions

## IR 29 i/Di

## Operations Manual



1194 Oak Valley Dr, Ste 20, Ann Arbor MI 48108 USA  
(800) 959-0329 • (734) 769-0573 • [www.goodforgas.com](http://www.goodforgas.com)



| <b>Table of Contents</b>   | <b>Page</b> |
|--|-------------|
| For your safety  | 2           |
| Operating instructions   | 2           |
| General description  | 3           |
| Measuring methods  | 3           |
| Device design  | 4           |
| Type plate with details of the transmitter version, serial number and ATEX certification | 4           |
| Site of installation for the transmitter   | 5           |
| Assembly   | 5           |
| Installing electrical connections  | 6           |
| Using the RC 2 or RC 3 Remote Control  | 8           |
| Commissioning  | 9           |
| Measuring mode   | 10          |
| Underrange   | 10          |
| Overrange  | 10          |
| Checking and AutoCal setting of the zero point (ZERO)                                    | 13          |
| Checking and AutoCal setting of the sensitivity (SPAN)                                   | 15          |
| Service menu and advanced service menu   | 16          |
| Layout of the service menu   | 18          |
| Displays and messages  | 21          |
| Displaying special statuses and malfunctions   | 21          |
| Fault messages of the main CPU   | 22          |
| Fault messages of the sensor CPU   | 23          |
| Displays in measuring mode   | 24          |
| Displays in service mode and during adjustment (status messages)                         | 24          |
| States of the status LEDs and the current output   | 26          |
| Displays and messages in measuring mode  | 26          |
| Initial commissioning and servicing  | 27          |
| Maintenance of fixed gas warning systems   | 27          |
| Regular functional tests   | 27          |
| Repairs  | 27          |
| Parts and accessories  | 28          |
| Connections and terminal assignment  | 29          |
| Measuring gases and measuring ranges   | 31          |
| Sensor specification   | 31          |
| Internal parameter memory of the IR 29 transmitter                                       | 33          |
| Technical data   | 34          |
| Appendix RC 3  | 36          |
| Application and purpose  | 36          |
| Operation  | 36          |
| Channel coding   | 36          |
| Changing batteries   | 37          |
| Technical Data   | 37          |
| Appendix SB1 / SB1D  | 38          |
| Operating instructions   | 38          |
| Device design  | 38          |
| Installing electrical connections  | 38          |
| Technical data   | 40          |

## For your safety

This user manual states the intended use of the product according to the manufacturer, GfG Instrumentation, and intends to prevent accidents and work-related injuries. It must be read and observed by all persons who operate, service, maintain and inspect this product. This product can serve its intended purpose only if it is operated, serviced, maintained and inspected according to the instructions given by GfG Instrumentation, Inc.

The warranty provided by GfG Instrumentation will become void if the product is not operated, serviced, maintained and inspected in accordance with GfG's instructions. The above does not affect statements regarding warranties and liabilities in the company GfG's General Terms and Conditions of Sale and Delivery.

## Operating instructions

After installation but before commencing operation, gas warning systems must be inspected by an expert to ensure they operate correctly and in accordance with national standards (commissioning).

The transmitter has been tested to ensure it is functioning correctly prior to delivery. Calibration and adjustment took place with appropriate test or calibration gases.

**This however does not release you from the obligation to commission the transmitter with test or calibration gas after installation.**

The IR 29 transmitter has been approved for application in potentially explosive atmospheres and has an EC Type Examination Certificate issued by DEKRA EXAM GmbH in accordance with Directive 94/9/EC.

Certificate: BVS 09 ATEX E 135 X

Certification:  II 1G Ex ia IIC T4 Ga -20°C ≤ Ta ≤ +55°C



### CAUTION

**The supply voltage should under no circumstances exceed 30 V DC! This also applies to voltage peaks!**

## General description

A fixed gas warning system consists of a transmitter and a controller unit (GMA, not included). The transmitter and the controller are interconnected by a shielded remote measurement cable. The transmitter converts the gas concentration into an electrical measuring signal. The evaluation of the measuring signal proportional to the existing gas concentration takes place at the controller (GMA).

The extensive electronics assumes various tasks which, on the one hand, facilitates operation and maintenance and, on the other hand, significantly enhances operational safety and measuring accuracy. The transmitter features the following:

- Concentration display on the display or remote control
- Settings without opening the housing with the RC 2 or RC 3 remote control
- Compensation of temperature influences
- Ex-protection in the temperature range -20 to +55 °C
- Functional test in the temperature range (see sensor specification)
- Permanent status display (operation / fault) at the transmitter

## Measuring methods

The sensors installed in the IR 29 transmitter work according to the IR absorption principle. Alignment to the gas type being monitored takes place using specific optical filters combined with suitable characteristics. The reduced IR radiation at the detector is converted into an electrical signal. This signal is amplified in the IR 29, filtered and used for the display or measured value transfer. Due to its design with two radiation sources, the measurement assembly offers a powerful signaling function and is less sensitive to interfering influences, such as deterioration of the radiators or temperature deviations. Soiling of the optics can also be compensated up to a certain degree. Due to the design and additionally available temperature and pressure compensation, influence caused by ambient conditions is almost entirely eliminated.

The electronics of the IR 29 transmitter converts the measuring signal into a linear measured value output 4...20 mA.

## Device design

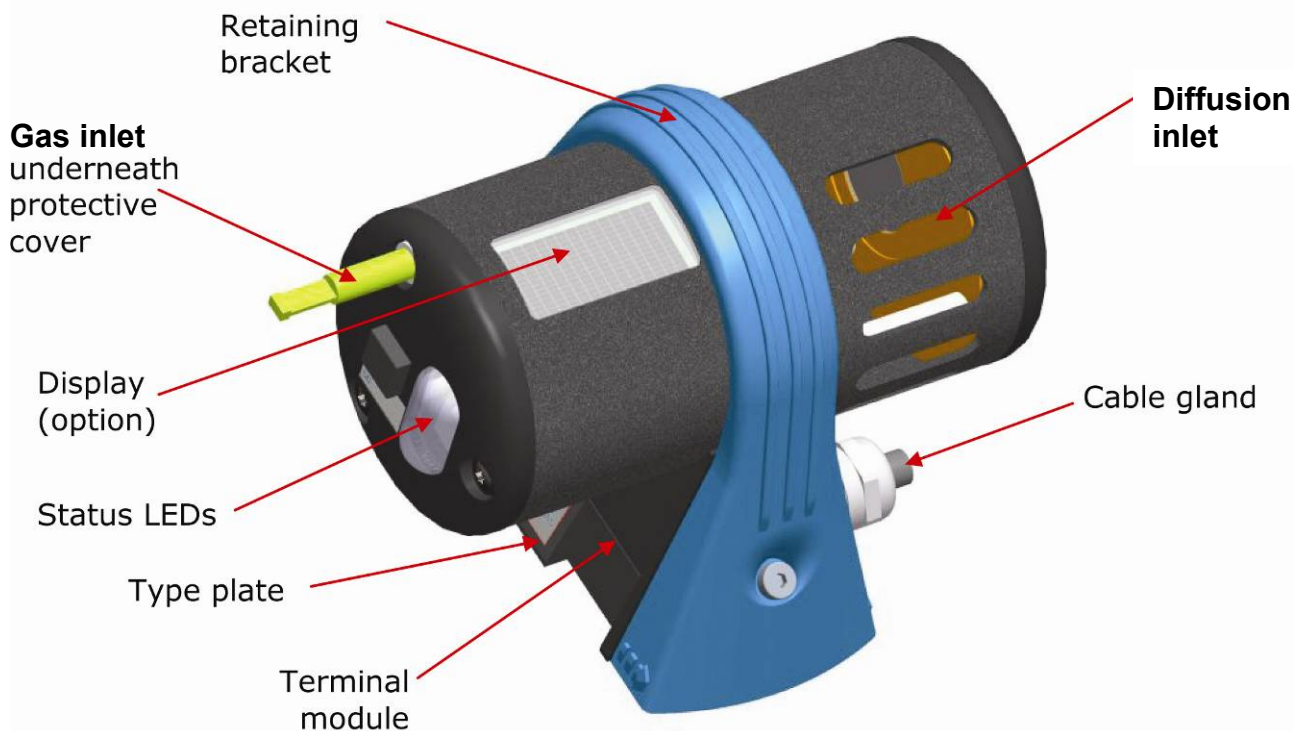

## Type plate with details of the transmitter version, serial number and ATEX certification



### Transmitter

Type designation & serial number

IR29  
SN:

### Type plate IR29

Gesellschaft für Gerätebau mbH - D-44143 Dortmund [www.gfg.biz](http://www.gfg.biz)

**IR29**  
BVS 09 ATEX E 135 X  
SN:

**Ex** II 1G  
Ex ia IIC T4 Ga  
QC:

**CE** 0158  
-20°C ≤ Ta ≤ +55°C

## Site of installation for the transmitter

When determining the site of installation, it is important to know the exact ambient conditions and to take them into consideration. In order to receive representative results, the ventilation conditions must be taken into account.

The position of the transmitter in the room must ensure that the gases still reach the sensor even in the event of unfavorable ventilation. If necessary, carry out a measurement, e.g. with ventilation smoke tubes.

When specifying the site of installation, it must be further observed that the transmitter can be accessed for service and calibration tasks. The transmitter must be installed in a horizontal position, with the measuring chamber on the left or right.

External influences must also be considered, such as:

- rainwater, splash water, dripping water, condensation
- the dust content in the atmosphere

The transmitter is protected against the ingress of water or dust to the greatest possible extent.

Special accessories can protect the transmitter against damage in extremely harsh measurement conditions. If desired, GfG will gladly advise you about suitable measures.



**The warranty may become void if the sensor is exposed to ambient conditions which were unknown to GfG Instrumentation during the planning phase or delivery.**

## Assembly

Assembly takes place step-by-step in the following sequence:



- 1) Loosen the screws "A" and remove the retaining bracket (1). To do so, slightly pull apart the ends of the bracket until the lugs are free.

2) Remove the transmitter (2) from the mounting bracket.

Depending on the type, the electrical plug-in connection is disconnected or the connector must be unplugged manually.

3) Unscrew the screws "B" and lift the top part of the mounting bracket (3) from the bottom part (4).

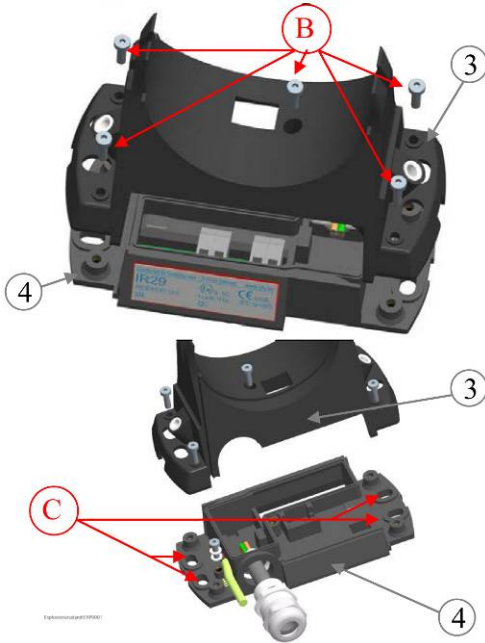

4) Fix the bottom part (4) into position at the site of installation; use the oval holes "C" and the screws provided for this purpose.

A drilling template is in the appendix to assist in the location of the holes.

Subsequently feed the line through the cable gland (fit the shield) and install the single conductors in the terminals X1-X4 (see next chapter).

Re-assemble in reverse order (steps 3-1).

## Installing electrical connections

The installation of remote measurement cables and the connection of the electrical installation must be carried out by a fully trained and qualified specialist in accordance with relevant regulations. Installation must occur with a shielded cable (e.g. Helukabel OZ-BL-CY 4X1.5 mm<sup>2</sup> or Lapp Cables ÖLFLEX® EB CY).

According to the manufacturer, the cables must meet the requirements of DIN EN 60079-14 or IEC 60079-14 section 12.2.2. (VDE 0165 Part 1). Furthermore, the installed remote measurement cables must be protected mechanically if both intrinsically safe circuits are conducted in one cable. This is necessary to prevent the two intrinsically safe circuits coming into contact.

Suitable mechanical protection depends on the operating situation, the site of installation and the hazard potential.

The conductor cross section is determined by the length of the connection line and the version of the transmitter. Remote measurement cables with a conductor cross section of 0.75 mm<sup>2</sup> can be used for short distances of up to 500 m. The conductor cross section must be 1.5 mm<sup>2</sup> for longer distances of up to 1,000 m.

The shielding is fitted in the M16x1.5 cable gland. A ground connection may be required for the IR 29 transmitter.

Only the transmitter can be installed in a potentially explosive atmosphere – the controller and the power supply unit must be installed outside this atmosphere.

If a ground connection of the housing is necessary, the ground connection terminal can be found at the lower section of the mounting bracket.





**The transmitter should only be installed when there is no gas present.**

If the transmitter is not operated with the GMA controller, the operating voltage of the connected power supply unit should not exceed 30 V DC even in the event of an error.

#### Connection diagram

X1: 18...30 V DC  
X2: 0 V GND  
X3: Data (D0) / 4...20 mA +  
X4: Data (D1) / 4...20 mA -

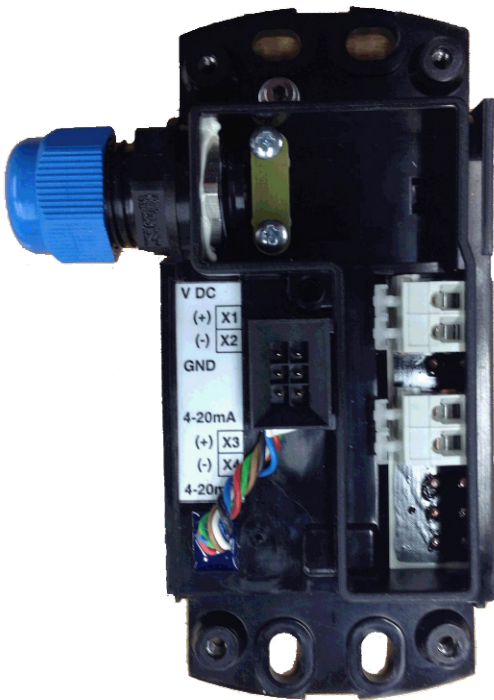

#### Ground Connection

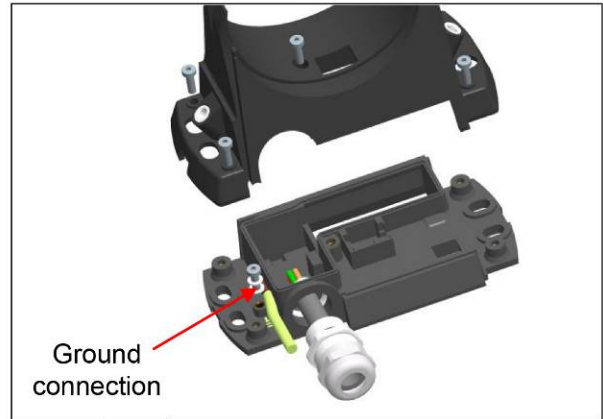

#### Ground connection:

On the side next to the cable gland at the lower section of the Mounting bracket

The ground connection must take place with a line cross section of 4 mm<sup>2</sup>.



**For service tasks, only the RC 2 remote control (BVS 04 ATEX E 212) should be connected to the transmitter, or the RC 3 remote control (BVS 08 ATEX E 006) in conjunction with an integrated display should be used at the transmitter.**

The RC 2 remote control and the IR RC 3 remote control can be used in potentially explosive atmospheres.

Settings of the zero point and display sensitivity (adjustment) can be executed directly at the optionally integrated display at the IR 29 transmitter and the RC 3 remote control or with the connected RC 2 remote control.



The buttons and functions of the RC 2 remote control are identical to those of the IR RC 3 remote control. Output in the transmitter display takes place in plain text format; output in the remote control RC 2 display occurs in abbreviated form.

## Using the RC 2 or RC 3 Remote Control

### Control buttons

The functions of the buttons at the RC 2 remote control and the IR RC 3 remote control are identical. The designation of the buttons at the RC 3 can be displayed by briefly pressing the central (oval) button at the display of the IR 29 transmitter.

### Display and LED test using the RC 2 or RC 3 remote control

In measuring mode, briefly press the  button to trigger a display and LED test. All the LEDs are subsequently activated for two seconds and all the segments of the display are shown.

## Commissioning

The IR 29 transmitter is tested to ensure it is functioning correctly prior to delivery. Calibration and adjustment takes place with a suitable test and calibration gas. Deviations may be identified depending on the transport, assembly and ambient conditions.

Therefore, the gas warning system must be commissioned and tested by GfG Instrumentation to ensure it functions correctly.

After switching it on, the gas warning system needs a few minutes to:

- carry out a self test during which the program and main memory are checked
- read and evaluate the device parameters with simultaneous memory check
- read and evaluate the sensor parameters with simultaneous memory check
- warm-up the sensor

The memory tests occur during the first few seconds of the switch-on phase. The current interface is set to 1.2 mA, the orange and green status LEDs illuminate. During the second step, the current interface is set to 1.6 mA, the fault LED illuminates and the operation LED flashes. The following is initially shown on the display: Reading device param. / **LOAD**. The measuring unit, the type of gas, the measuring range and the calibration gas concentration are subsequently shown one after the other at the devices equipped with a display or at the RC 2 remote control.

The IR 29 transmitter switches to the warm-up phase of the sensor, the fault LED flashes and the operation LED indicates readiness at 5 second intervals by flashing briefly – the remaining time is shown on the display in seconds.

The measuring mode is automatically activated after the warm-up phase.

If a device error is detected during the start-up phase, the IR 29 transmitter switches to error mode. The current interface is set to 1.2mA, an error message is shown on the display of the transmitter (if available) or via the RC 2 remote control (see Displaying special statuses and malfunctions). The fault LED is permanently lit. The display lighting additionally flashes with display versions.

### Note:

Initial commissioning demands adjustment of the zero point (AutoCal ZERO) after the warm-up phase and a subsequent sensitivity test, as well as possible adjustment (AutoCal SPAN).

## Measuring mode

Measurement of the gas concentration occurs continuously. Functions of the electronics system, such as parameter memory or the sensor function, are monitored permanently. In trouble-free measuring mode, the green operation LED lights up, the orange fault LED is off.

**The currently measured value is shown if the transmitter is equipped with a display.  
The measured value display at a connected RC 2 remote control is identical.**

When using an IR 29 without a display, the display of the RC 2 remote control changes from gas concentration to gas unit and type of gas at one minute intervals.

When using an IR 29 with a graphical display, a pending measured value ( $>0$ ) is shown as a bar graph, which always displays the current measured value in addition to the numerical display (the measuring gas and measuring unit are shown every 30 seconds instead of the bar graph). With display "0.0", the measuring gas and measuring unit are always displayed instead of the bar graph.

## Underrange

Measured values below the zero point are displayed as numerical values with a negative sign.

The current interface outputs a signal of between 2.8 mA and 3.9 mA according to the measured value.

If the zero point deviation is too high, the current interface is permanently set to 2.8 mA, and transmitters equipped with a display permanently show  $\downarrow\downarrow\downarrow$  and are referred to as underrange.

## Overrange

Transmitters equipped with a display,  $\uparrow\uparrow\uparrow$  / ---- and the measured value are alternately displayed if the measuring range has been exceeded by up to 112.0 %. The current interface provides an output signal of between 20...22 mA according to the measured value.

If the measured value exceeds 112.0 % of the measuring range,  $\uparrow\uparrow\uparrow$  / ---- flashes on the display and are referred to as overrange. The current interface is set to 22 mA.

## Display of operating parameters (IR 29 with display)

During measuring mode, briefly press the  button at the RC 2 or RC 3 remote control to automatically display the following important operating parameters one after the other:

1)

- Measuring gas 1
- Measuring unit 1
- Measuring range 1 (....)
- Calibration gas concentration 1 (.....)

2)

- Mean value of the last recorded 8 hours ( ... 2 )
- Mean value of the last recorded 15 minutes ( .... 3 )

1 These displays also appear during the switch-on phase



2 TWA (Time Weighted Average)





3 STEL (Short-Term Exposure Limit)

Here is an example of a display sequence for the RC 2 remote control with a 7-segment display on an IR 29 i transmitter:

**VOL H2 SCAL 4.0 CGAS 1.0 EUR 0.3 SEEL 0.1**

## Measured value histogram

When using a graphical display, it is possible to change to a different display mode. After triggering the display of the operating parameters by pressing . Briefly press  again to display the histogram selection.

It is possible to view data of the last 2 hours, 8 hours or 24 hours (select by pressing the  or  button, press  to acknowledge your selection). The histogram display mode subsequently appears. It is possible to display average values, maximum values and minimum values by (briefly) pressing the  or  button again.

Saved measured values are displayed in graphical form instead of the measured value. The currently pending measured value is additionally shown in the top section together with the type of gas and gas unit. The histogram is refreshed at regular intervals and can be used as a permanent display mode.

Briefly press  or appearing special messages to exit this display mode.

## Sensor service life

The applied IR radiator has a limited service life. If the signal level falls below 85 % of the original value, a display is activated stating that the optics must be checked for possible soiling at the latest during the next maintenance period. The IR 29 transmitter must be replaced if it has become heavily soiled or worn.

This is displayed by the regular brief flashing of the fault LED and by the display Device replacement / **CHNG IR 29** alternating with the measured value. If the signal level falls below 80 % of the original value, the transmitter switches off the measuring mode Sensor service life exceeded / **CHNG IR 29**). The current interface is set to 1.2 mA, the orange fault LED illuminates and the green operation LED flashes at regular intervals

## **Device fault**

If the transmitter is faulty, the fault LED (orange) lights up permanently, the current interface is set to 1.2 mA and an error message appears on the display (see Displaying special statuses and malfunctions).

A fault occurs, if:

- the sensor or the electronics in the transmitter is defective,
- errors occur during self monitoring of the device.

For further causes, please see Displaying special statuses and malfunctions.  
The orange fault LED discontinues once the fault has been eliminated.

## Checking and AutoCal setting of the zero point (ZERO)

Setting zero point must be performed in a fresh (clean) air environment or Synthetic air can also be used if the atmosphere is contaminated.

The calibration adaptor must be used for checking and setting. Synthetic air can be applied unpressurized by using the calibration adaptor with a flow rate of approximately 0.5 l/min.

If the zero point display deviates in measuring mode, a zero point offset is necessary. The zero point also has to be reset after changing the measuring gas.

The AutoCal program ensures independent setting of the zero point signal under the conditions specified above.

## Activation

The zero point can only be set via the RC 2 or RC 3 remote control (only possible with IR 29 transmitter with a display).

Automatic zero point offset can only be executed after entering access code **0011** if the currently displayed value is max. 10 % of the maximum measuring range.

An experienced user can activate the zero point setting after entering access code **0055** with a display of up to 15 % of the maximum measuring range. This access code should only be used by fully trained staff.

If the current zero point display exceeds a value of 15 % of the maximum measuring range and it has been ensured that the display was not caused by the presence of gas, a temporary hour code (valid for max. 1 hour) can be read in the Info / **Info** submenu of the service menu (Zero Code / **Code**) and used to activate zero point setting without restrictions.





### Note:

The necessity of the latter measure might be an indicator of a defective sensor and thus of the need to replace the sensor as quickly as possible.

## Adjustment

Adjustment takes place in three steps using the RC 3 and the IR 29 display or the RC 2 remote control:

1. Press the  button for a longer period (at least 3 seconds) to start activation. After activation, the current interface supplies 2.0 mA throughout the entire process and the fault LED flashes at slow intervals. The following appears on the display: Code / **CODE**.

2. The numerical access code **0011** or **0055** must be entered (this access code should only be used by fully trained staff of the operator). Use the  and  buttons to change the number at the current position and  to acknowledge the changes. Press the  button for a longer period to delete the last acknowledged number.

If the entry was correct, the current measured value is shown on the display alternating with Zero / **ZERO**. If the measured value remains constant during a defined time interval, a new zero point is set. The AutoCal program is then automatically exited with Save / **SAVE** and returns to measuring mode.

Note:

If the current measured value is outside the permissible limits for the respective access code, the display Code incorrect / **FAIL** is shown briefly at Point 3 and the device returns to measuring mode.

The AutoCal program can be shortened to a constant measured value by pressing the button for a longer period (3 seconds) during the inspection. The hardware then begins zero point setting.

In order to cancel the AutoCal program without zero point setting during the waiting period, just press the button or the AutoZero button briefly.

The following appears on the display: Cancel / **ESC** Press the button to acknowledge it.

The following error messages can occur when setting the zero point:

| Display                             | Comment   | Fault LED     |
|-------------------------------------|---|---------------|
| <i>Cal. error no. 2 / [RL Err.2</i> | The gas signal is unstable                                | fast flashing |
| <i>Cal. error no. 3 / [RL Err.3</i> | The zero point is outside the permissible tolerance range |               |

All error messages must be acknowledged with . After acknowledgement with the unchanged zero point setting, the transmitter returns to measuring mode.



## Checking and AutoCal setting of the sensitivity (SPAN)

The RC 2 or RC 3 remote control is required for devices without a display in order to carry out calibration and adjustments.

Initially, check the set calibration gas concentration by pressing briefly. The value of the calibration gas concentration must be at least 20 % of the measuring range.



**Always observe special safety precautions when handling toxic gases. MAC values indicate hazards caused by toxic gases.**

Use the IR 29 calibration adaptor to check and adjust the sensitivity of the display. The calibration gas is fed unpressurised through the gas inlet with a volume flow of approx. 0.5 l/min. The gas concentration can be checked directly on site on the RC 2 display. If the display deviates from the calibration gas concentration, the sensitivity must be set.

**The sensor must be free from calibration gas (reading zero) prior to each re-adjustment.**

Adjustment takes place in four steps using the RC 3 and the IR 29 display or the RC 2 remote control:

1. Press the button for a longer period (at least 3 seconds) to start activation. After activation, the current interface supplies 2.0 mA throughout the entire process and the fault LED flashes at slow intervals. The following appears on the display: Code / **CODE** 2. The numerical access code **0011** or **0055** must be entered (this access code should only be used by fully trained staff of the operator). Use the and buttons to change the number at the current position and to acknowledge the changes. Press the button for a longer period to delete the last acknowledged number.
3. After correct entry, the expected calibration gas concentration is shown on the display. This must be set to the value of the calibration gas (printed on the cylinder) and acknowledged (proceed as described under 2).
4. The current measured value and Span / **SPAN** are shown alternately on the display. The device subsequently waits for a noticeable increase in the concentration. If the measured value remains constant during a defined time interval (after a fixed waiting period of 2 min.), the measured value is accepted for refreshing the sensitivity (display Save / **SAVE**). The adjustment data has then been saved successfully.
5. However, the transmitter does not yet return to measuring mode, as a still pending concentration of calibration gas could trigger alarms. The transmitter remains in adjustment mode until there is a decrease in the gas concentration and stabilization of the display value is subsequently detected. Meanwhile, Zero / **ZERO** is shown on the display alternating with the current measured value. The device returns to measuring mode after stabilization. If no gas decrease and stabilization of the measured value is detected, the device automatically returns to measuring mode after 3 minutes.

### Note:

The AutoCal program can be shortened in each phase by pressing the button for a longer period. Save / **SAVE** appears briefly on the display and the measured value is accepted directly to refresh the sensitivity.

Only press the button briefly to cancel the AutoCal program without setting the sensitivity. Cancel / **ESC** appears on the display and must be acknowledged by pressing the  button. Subsequently, it is returned to measuring mode as described under 5.

The following error messages can occur when setting the sensitivity:

| Display                              | Comment   | Fault LED     |
|--------------------------------------|---|---------------|
| <i>Cal. error no. 1 / [CAL Err.1</i> | An increase in calibration gas was not detected           | fast flashing |
| <i>Cal. error no. 2 / [CAL Err.2</i> | The gas signal is unstable                                |               |
| <i>Cal. error no. 3 / [CAL Err.3</i> | The gas signal is outside the permissible tolerance range |               |

Acknowledge the error messages with . The transmitter changes to measuring mode without re-adjustment, the data of the last valid calibration is used, and the adjustment must be repeated.

## Service menu and advanced service menu

### Activate the service menu

All important parameters of the IR 29 transmitter can be opened and changed in the service menu. The measuring mode is interrupted when opening the service menu and the device changes to service mode. The special status "Service" is indicated by the slow flashing fault LED and the output signal is set to 2.4 mA. If the user does not press any button, the device automatically exits the service mode after one minute and returns to measuring mode.

**All parameter changes carried out in the service menu relate to the currently set type of gas!**

If the type of gas and parameters are to be changed, the new type of gas must be set first before parameter changes can become effective for this type of gas.





Two service menu versions are available.



The standard service menu is opened with access code **0011** It is not possible to change important settings, such as measuring gas or measuring range end value, here. Such attempts are ignored and the message Locked / **FAIL** appears.

The advanced service menu is opened with access code **5050** All settings can be carried out without restrictions in the advanced service menu. This access code should only be used by specifically trained staff of the operator.



Execution takes place in three steps using the RC 3 and the IR 29 display or the RC 2 remote control:

1. Press the  button for at least 3 sec. The transmitter changes to service mode. The following appears on the display: Code / **CODE**

2. Now enter the numerical access code **1100** or **5050** Use the  and  buttons to change the number at the current position and  to acknowledge the changes. Press the  button for a longer period to delete the last acknowledged number.

3. After correct entry, the service menu opens with menu item Gas / **GAS**. Use the  and  buttons to select other menu items.

## Operation

A menu item is selected using the  and  buttons.

After selection, briefly press the  button to activate a desired menu item or to select a parameter.

The service menu can be exited with or without saving the changed parameters.

### Note:

It is possible to change several parameters one after the other without having to save the changes individually. All the parameters previously changed in the submenus are saved when exiting the service menu through the menu item save.

### **Exceptions:**

- 1) Changing the type of gas – if a different type of gas is selected in the "Gas" menu, it is saved immediately, the parameters for this type of gas are activated and the IR 29 transmitter restarts with the changed parameters.
- 2) When setting the time and date, they are saved immediately.

Some parameters are related to each other. Therefore, other parameters might be adjusted automatically after changing a parameter.

# Layout of the service menu

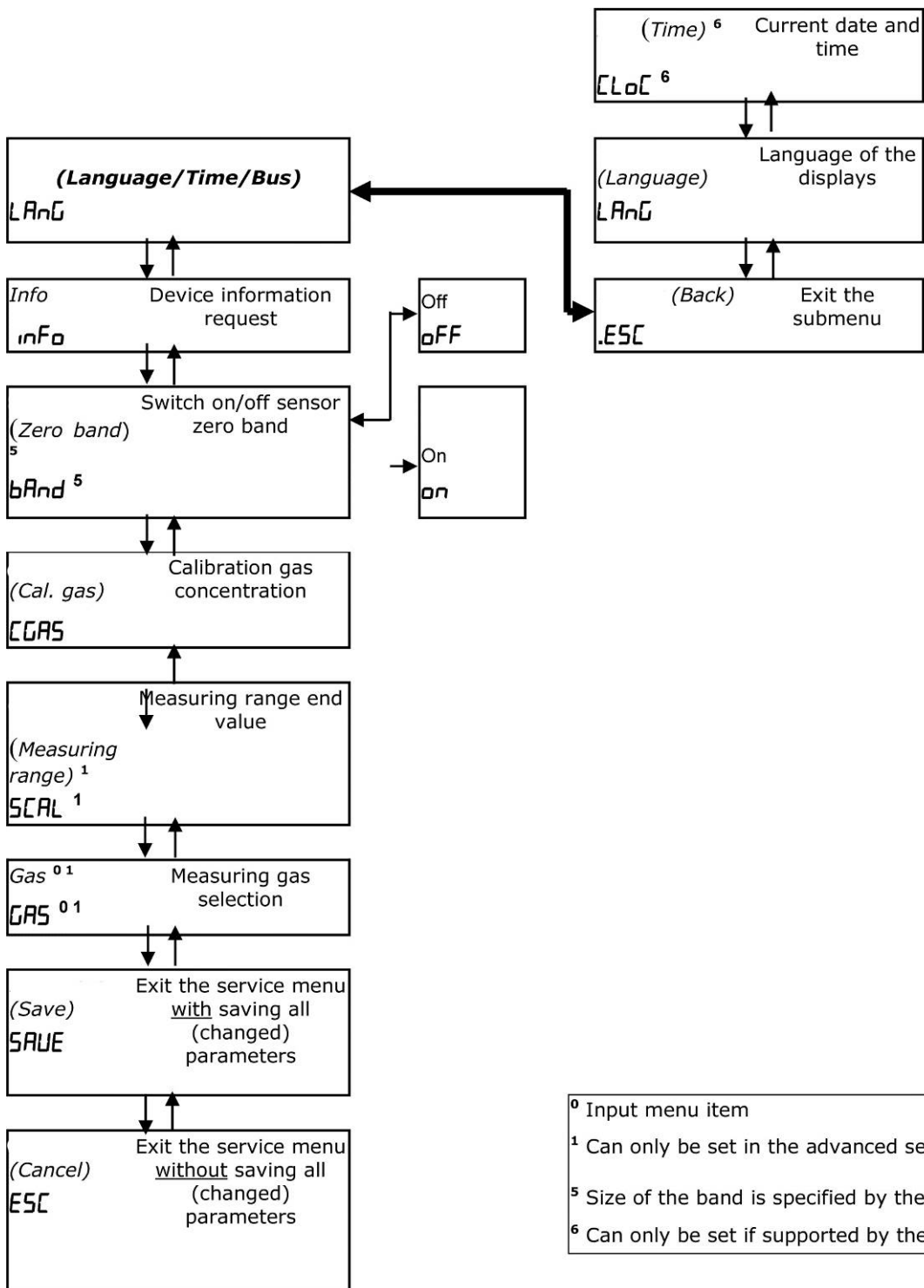

## Additional menu explanations

### Cancel

Exit the service menu without saving the parameters, changes are discarded.

### Save

Exit the service menu with saving all the changes to the parameters.

### Gas

The gas type and the parameters stored in the sensor can be selected using this function. Only gases are displayed for which the sensor is intended and for which it has been programmed.

#### Note:

If a changeover to a different type of gas occurs, the IR 29 transmitter will restart. Changing to a new type of gas always requires an adjustment of the zero point (AutoCal ZERO) after its warm-up time and subsequently a sensitivity check, and, if necessary, an adjustment (AutoCal SPAN).

There are no restrictions for the first zero point setting after a gas change.

After a gas changeover, parameters, such as the measuring range and the calibration gas concentration, must be checked and, if necessary, adjusted.

### Measuring range

The measuring range end value can be set in steps to 10.0, 15.0, 20.0, 25.0, 30.0, 40.0, 50.0, 75.0, 100.0 % of the maximum measuring range, but not smaller than 1/6 of the maximum measuring range end value.

#### Note:

Changing the measuring range is predominantly an adjustment of the output signal. The standardized output signal 4...20 mA is used for the new measuring range. The numerical display does not change.

### Cal. Gas

A default value is pre-set as the calibration gas concentration. This value must be compared to the value set on the test gas cylinder and, if necessary, adjusted.

### Zero band

The zero band of the sensor can, if required, be deactivated, the true measured value is also displayed around the zero point.

Possible settings:

- Zero band activated (On / **On**)
- Zero band activated (Off / **Off**)

### Info

Retrievable/Displayed device information:

- Sensor type/MK number (sensor type / **S.TYP**)
- Sensor serial number (sensor no. / **S.NR**)
- Software version (software ver. / **S.NR**)
- Transmitter serial number (serial no. / **F.NR-F.Nr**)
- Hour code (ZERO Code / **CODE**)

Note:

The number shown under ZERO Code / **CODE** is an access code that is valid for a limited period of time and can be used to activate the zero point setting without restrictions (see AutoCal ZERO).

With a RC 2 remote control connected, the individual displays must be shifted by pressing .

**Language/Time/Bus → Language**

Possible language settings:

- German (Deutsch / ...)
- English (English / ....)
- Spanish (Espanol / ...)

Note:

The language setting generally influences the presentation on the graphical display.

**Language/Time/Bus → Time**

Setting sequence: Year, month, day, hour, minute

## Displays and messages

### Displaying special statuses and malfunctions

The following table lists the special statuses for which the orange fault LED is permanently illuminated and the current interface is set to =1.6 mA. When using a IR 29 transmitter without a display, the following error messages should be displayed with the RC 2 remote control for improved diagnosis or the exact value of the output signal analyzed.

| No  | Display   | Green LED | Orange LED | Current output | Cause  | Note/Explanation  |
|-----|---|-----------|------------|----------------|--|---|
| 001 | <i>Device test</i><br>ŁŁŁŁ  | On        | On         | 1.2 mA         | Program and memory tests at the start of system start-up                     |   |
| 002 | <i>Read device parameters</i><br><br>Operating parameters<br>ŁŁŁŁ<br>Operating parameters | Flashes   | On         | 1.6 mA         | Start up the system (during start, after measuring gas or sensor changeover) | Switches automatically to "Display of operating parameters", subsequently to the sensor warm-up phase |
| 003 | <i>Warm up sensor</i><br><br>elapsing seconds<br>elapsing seconds                         | Flashes   | On         | 1.6 mA         | Sensor warm-up phase   | Automatically changes to measuring mode after expiration  |

## Fault messages of the main CPU

| No. | Display   | Green LED       | Orange LED | Current output | Cause   | Note/Explanation   |
|-----|---|-----------------|------------|----------------|---|--|
| 101 | <i>Sensor service life exceeded</i><br>[HnG 5Er5]                       | Flashes quickly | On         | 1.2 mA         | Sensor service life expired   | Replace device   |
| 102 | <i>Acknowledge gas change</i><br>[HEC GAS]                              | Double pulses   | On         | 1.2 mA         | The sensor is not specified for the measuring gas (after sensor change)   | Change the gas again, otherwise replace the device                           |
| 103 | <i>Acknowledge measuring range</i><br>[HEC SCAL]                        | Double pulses   | On         | 1.2 mA         | Measuring range setting of sensor and device differ (after sensor change) | Check measuring range SCAL and change it, if necessary (after sensor change) |
| 104 | <i>System error-104-main memory defective</i><br>Err. 104               | Off             | On         | 1.2 mA         | Error while accessing RAM   | Restart the device. If the error message is shown again, replace the device  |
| 105 | <i>System error-105-prog. memory defective</i><br>Err. 105              | Off             | On         | 1.2 mA         | Error while accessing ROM   |  |
| 106 | <i>System error-106-param. memory defective</i><br>Err. 106             | Off             | On         | 1.2 mA         | Error while accessing EEPROM (internal)                                   |  |
| 109 | <i>Sensor error-109-communication error sensor CPU</i><br>Err. 109      | Off             | On         | 1.2 mA         | No/Faulty communication with sensor                                       |  |
| 110 | <i>Sensor error-110-communication error pressure sensor</i><br>Err. 110 | Off             | On         | 1.2 mA         | No/Faulty communication with pressure sensor                              | Restart the device. If the error message is shown again, replace the device  |
| 111 | <i>Sensor error-111-communication error humidity sensor</i><br>Err. 111 | Off             | On         | 1.2 mA         | No/Faulty communication with pressure humidity sensor                     |  |
| 112 | <i>System error-112-ADC addressing</i><br>Err. 112                      | Off             | On         | 1.2 mA         | Addressing of the AD converter channels faulty                            | Restart the device. If the error message is shown again, replace the device  |



|     |  |                 |    |        |  |   |
|-----|--|-----------------|----|--------|--|---|
| 113 | System error-113-<br>RAM parameters<br>Err. 113              | Off             | On | 1.2 mA | Cyclic check of the operating parameters in the RAM failed         |   |
| 115 | Sensor error-115-<br>insuff. signal level<br>Err. 115        | Flashes quickly | On | 1.2 mA | The signal level is insufficient for a precise measurement (<80 %) | Replace the device  |
| 116 | System error-116-<br>read back current interface<br>Err. 116 | Off             | On | 1.2 mA | Output error of the current interface                              | Restart the device. If the error message is shown again, replace the device |
| 118 | System error-118-<br>check voltage supply<br>Err. 118        | Off             | On | 1.2 mA | Voltage supply <12 V, measuring mode not possible                  | Check and reset the voltage supply  |

## Fault messages of the sensor CPU

| No. | Display   | Green LED | Orange LED | Current output | Cause  | Note/Explanation  |
|-----|---|-----------|------------|----------------|--|---|
| 120 | SenCPU error-120-<br>main memory defective<br>Err. 120      | Off       | On         | 1.2 mA         | Error while accessing RAM                          | Restart the system. If the error remains, replace the device. |
| 121 | SenCPU error-121-<br>prog. memory defective<br>Err. 121     | Off       | On         | 1.2 mA         | Error while accessing ROM                          |   |
| 122 | ADU error-122-<br>error temperature measurement<br>Err. 122 | Off       | On         | 1.2 mA         | Error A/D converter (temperature measurement/NTC)  |   |
| 123 | ADU error-123-<br>"stuck at"<br>Err. 123                    | Off       | On         | 1.2 mA         | AD converter Multiplexer or AD converter defective |   |
| 124 | ADU error-124-<br>overrange<br>Err. 124                     | Off       | On         | 1.2 mA         | AD converter Measured value too large              |   |
| 125 | ADU error-125-<br>underrange<br>Err. 125                    | Off       | On         | 1.2 mA         | AD converter Measured value too small              |   |

## Displays in measuring mode



| No. | Display                                      | Green LED | Orange LED    | Current output | Cause  | Note/Explanation   |
|-----|--|-----------|---------------|----------------|--|--|
| 201 | ↑↑↑↑<br>permanent                            | On        | On            | 22 mA          | The gas concentration has considerably exceeded the measuring range ( $\geq 112.5\%$ of the measuring range) |  |
|     | "----"<br>permanent                          |           |               |                |  |  |
| 203 | Measured value<br>alternating with<br>↑↑↑↑   | On        | Off           | 20..22 mA      | The gas concentration has exceeded the measuring range (100...112.5% of the measuring range)                 | Minimise the gas concentration!!!                          |
|     | Measured value<br>alternating with<br>"----" |           |               |                |  |  |
| 207 | Check voltage<br>supply                      | On        | Off           | 4..20 mA       | Precautionary warning message:<br>The voltage supply is not within the required range                        | Check and reset the voltage supply                         |
|     | CHEC SUPP                                    |           |               |                |  |  |
| 209 | Measured value                               | On        | Off           | 4..20 mA       | Trouble-free measuring mode  |  |
| 210 | Measured value                               | On        | Off           | 2.8..4 mA      | Underrange signal (-7.5...0.0% of the measuring range)   | Zero point offset might be necessary                       |
| 211 | ↓↓↓↓<br>permanent                            | On        | On            | 2.8 mA         | Underrange signal (<-7.5 % of the measuring range)   | Zero point offset is necessary                             |
|     | "----"<br>permanent                          |           |               |                |  |  |
| 213 | Low signal level                             | On        | Double pulses | 4..20 mA       | Reference signal in the range 80-85 % of the original signal   | Check the optics for soiling, otherwise replace the device |
|     | LSIG   |           |               |                |  |  |

### Notes:

In measuring mode, the messages listed in the second column are shown alternating with the measured value. The display described under No. 207 represents a precautionary warning message. The transmitter remains in measuring mode and the operator does not need to react immediately. The statuses described under No. 203 and No. 210 refer to the extension of the evaluation of the output signal 4...20 mA to 2.8...22 mA in order to display deviations while taking into account the tolerances in the default measuring range.

## Displays in service mode and during adjustment (status messages)

| No. | Display   | Green LED | Orange LED | Current output | Cause  | Note/Explanation  |
|-----|-----------|-----------|------------|----------------|--|---|
| 301 | Menu item | On        | Flashes    | 2.4 mA         | The service menu has been activated via the keyboard or the RC 2   | Select menu item<br>If there is no entry for one minute, it is automatically returned to measuring mode |
| 302 | ZERO      | On        | Flashes    | 2.0 mA         | The AutoCal setting of the zero point has been activated via the keyboard, the RC 2 or the AutoZero button | Automatic termination after successful adjustment   |
|     | ZErD      |           |            |                |  |   |
| 303 | SPAN      | On        | Flashes    | 2.0 mA         | The AutoCal setting of the sensitivity has been activated via the keyboard or the RC 2                     | Automatic termination after successful adjustment   |
|     | SPRn      |           |            |                |  |   |

|     |   |    |                    |        |   |   |
|-----|---|----|--------------------|--------|---|---|
| 304 | <i>Cal. error<br/>no conc. change</i>           | On | Flashes<br>quickly | 2.0 mA | No increase in the calibration<br>gas concentration has been<br>detected during the AutoCal<br>setting of the sensitivity | Acknowledge with <br>a) Check gas supply<br>b) Only apply gas after<br>activating the adjustment                                  |
|     | [AL Err.1]                                      |    |                    |        |   |   |
| 305 | <i>Cal. error<br/>gas unstable</i>              | On | Flashes<br>quickly | 2.0 mA | No stable zero gas or<br>calibration gas concentration<br>has been detected during<br>the AutoCal setting                 | Acknowledge with <br>a) Stabilize gas supply   |
|     | [AL Err.2]                                      |    |                    |        |   |   |
| 306 | <i>Cal. error<br/>calibr. not<br/>plausible</i> | On | Flashes<br>quickly | 2.0 mA | The zero point or the<br>sensitivity is outside the<br>permissible tolerance range  | Acknowledge with <br>a) Check the zero or<br>calibration gas and repeat<br>the process<br>b) If necessary, replace the<br>sensor |
|     | [AL Err.3]                                      |    |                    |        |   |   |

## States of the status LEDs and the current output

For improved clarity, the following table shows the various displays of both status LEDs and the current output signals as well as their meaning for a IR 29 transmitter without a display.

The RC 2 remote control is mandatory for a device without a display in order to offset the zero point, to carry out adjustments and to call the service menu.

| Green LED     | Orange LED      | Current output | For a description, see section ...                         |
|---------------|-----------------|----------------|--|
| On            | On              | 2.8 mA         | <i>Displays in measuring mode</i> No. 211                  |
| On            | On              | 1.2 mA         | <i>Displaying special statuses...</i> No. 001              |
| On            | On              | 22 mA          | <i>Displays in measuring mode</i> No. 201                  |
| On            | Flashes quickly | 2.0 mA         | <i>Displays in service mode...</i> No. 304-306             |
| On            | Flashes         | 2.4 mA         | <i>Displays in service mode...</i> No. 301                 |
| On            | Flashes         | 2.0 mA         | <i>Displays in service mode...</i> No. 302, 303            |
| On            | Double pulses   | 4..20 mA       | <i>Displays in measuring mode</i> No. 213                  |
| On            | Off             | 20..22 mA      | <i>Displays in measuring mode</i> No. 203                  |
| On            | Off             | 4..20 mA       | <i>Displays in measuring mode</i> No. 207, 209             |
| On            | Off             | 2.8..4 mA      | <i>Displays in measuring mode</i> No. 210                  |
| Flashes       | On              | 1.6 mA         | <i>Displaying special statuses...</i> No. 002, 003         |
| Single pulses | On              | 1.2 mA         | <i>Displaying special statuses...</i> No. 101, 115         |
| Double pulses | On              | 1.2 mA         | <i>Displaying special statuses...</i> No. 102, 103         |
| Off           | On              | 1.2 mA         | <i>Displaying special statuses...</i> No. 104-113, 116-125 |

## Displays and messages in measuring mode

The displays of the various messages take place with different frequencies of occurrence according to their influence on the measuring process.

The table gives an overview of which messages influence the measuring mode.

| Measuring mode | Message          | For a description, see section ...                     |
|----------------|------------------|--|
| No             | Fault messages   | <i>Displaying special statuses...</i> No. 101, 104-125 |
| Yes            | Warning messages | <i>Displays in measuring mode</i> No. 207, 213         |
| Interrupted    | Status messages  | <i>Displays during adjustment</i> No. 301-306          |

**Fault messages** (system and sensor errors No. 101 and No. 104-125) terminate the measuring mode until they have been eliminated. They are shown permanently on the display and are additionally output via the LED code specified above (also with version without a display).

**Warning messages** allow the continuation of the measuring mode, but might have to be acknowledged or are self-acknowledging. They are displayed alternating with the measured value. If there are several warning messages pending, they are displayed cyclically.

Example:

Warning messages 207 and 213 are pending. These messages are output on the display in the following sequence:

....measured value...message 207....measured value....message 213....measured value....message 207....etc.

**Status messages** are special messages which are triggered by special functions and interrupt the measuring mode. All these messages and statuses are self-resetting after a certain period of time. The transmitter then re-assumes the measuring mode independently.

## **Initial commissioning and servicing**

DIN EN 60079-29-2 "Gas detectors – Selection, installation, use and maintenance of detectors for flammable gases and oxygen" as well as the relevant national rules and regulations must be observed. During initial start-up, gas warning systems must be checked for proper functioning by an expert after installation. (see DIN EN 60079-29-2 section 8.9 and data sheet BGI 518 / T023 section 8.1). Servicing includes inspection, maintenance, calibration and adjustment, as well as regular functional tests and repairs. Tests must be carried out by an expert and written confirmation of the result must be provided.

## **Maintenance of fixed gas warning systems**

The maintenance of fixed gas warning systems includes:

Monthly visual inspections to check for:

- Mechanical damage
- Dust contamination
- Condensation due to moisture
- Safety equipment for transmitters
- Diffusion openings of the transmitters
- Gas extraction system, gas treatment (if available)

Functional check, Interval: 4 months

Scope of the functional checks:

- Calibrations (measured value display) using zero and calibration gas
- Adjustment of the zero point and sensitivity setting using zero or calibration gas
- Triggering alarm thresholds
- Setting time
- Output functions, optical and acoustic
- Fault messages

System checks (section 9.3), Interval: 1 year

It is recommended to contact Customer Service for maintenance.

## **Regular functional tests**

Tests must be carried out by an expert and written confirmation of the result must be provided.

## **Repairs**

This includes all repair and replacement parts. Only use original spare parts and original modules inspected and approved by the manufacturer.

## Parts and accessories

|    | <b>Description</b>  | <b>Part Number</b> |
|----|---|--------------------|
| 1. | Double safety barrier (Type: SB1), two channel, for IR 29 integrated in a wall mounting case (IP65)   | 2910210            |
| 2. | Diffusion cover for adjusting IR 29, material: viton  | 2910220            |
| 3. | RC3 - Remote control, infrared remote control for IR 29   | 2910230            |
| 4. | RC2 - Remote control, Required for calibration of blind transmitters; option for transmitters with display. Includes 6-foot connection cable. | 2800201            |
| 5. | Connection cable for RC2 Remote Control. 6 feet   | 2800210            |
| 6. | Connection cable for RC2 Remote Control. 16 feet  | 2800211            |
| 7. | Connection cable for RC2 Remote Control. 33 feet  | 2800213            |

## Connections and terminal assignment

### IR 29 with 4..20 mA interface and Zener barriers

- |    |   |
|----|---|
| 1: | Supply 22...27 V DC<br>(upstream of the Zener barrier, see section <i>Accessories</i> ) |
| 2: | Supply 0 V GND  |
| 3: | 4..20 mA – supply<br>22...27 V DC<br>(upstream of the Zener barrier)                    |
| 4: | 4..20 mA – GND  |

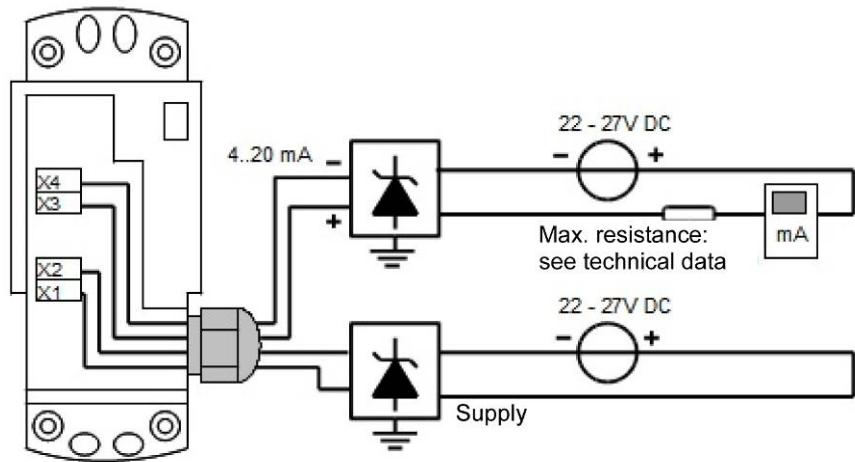

### IR 29 i with 4..20 mA interface and SB1

- |    |   |
|----|---|
| 1: | Supply 19...30 V DC<br>(upstream of the SB1, see section <i>Accessories</i> ) |
| 2: | Supply 0 V GND  |
| 3: | 4..20 mA – supply<br>via SB1  |
| 4: | 4..20 mA – GND  |

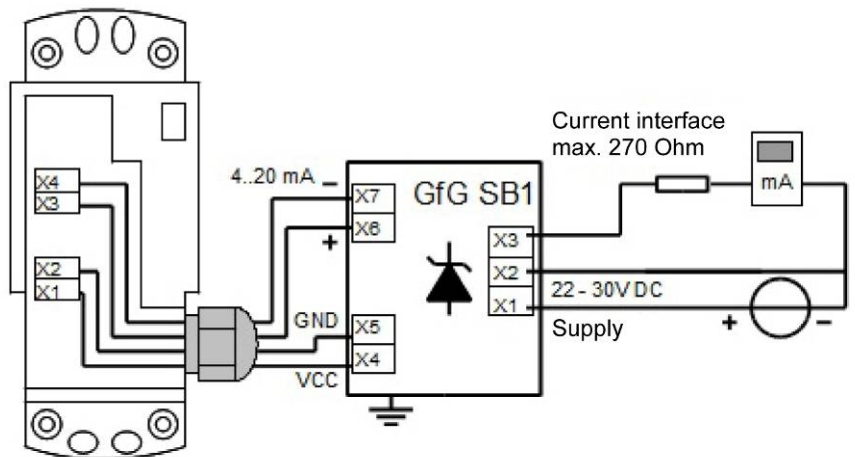

## IR 29 i with 4..20 mA interface and 3-wire cable (e.g. GMA41)

- |    |                        |
|----|------------------------|
| 1: | Supply VCC via the GMA |
| 2: | Supply 0 V GND         |
| 3: | Bridged to X1          |
| 4: | 4..20 mA               |

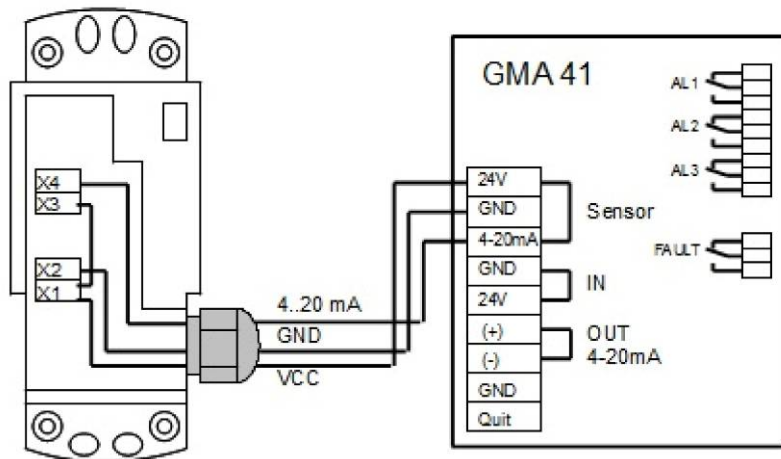

### CAUTION!

Cabling must take place with strands to establish the required bridge X1-X3. Both conductors in X1 must be inserted correctly into a common, sufficiently dimensioned wire and ferrule.

The application of different conductors (solid wire and strand) is not permitted!

The application of several solid wires in one wire end ferrule is not permitted!





| <b>MK242-1 IR sensor for combustible gases and vapors</b> |  |                        |                               |   |                  |                           |            |   |                  |
|---|--|------------------------|-------------------------------|---|------------------|---------------------------|------------|---|------------------|
| Measuring range   | 0.0...100 % LEL  |                        |                               |   |                  |                           |            |   |                  |
| Resolution  | 0.5 % LEL  |                        |                               |   |                  |                           |            |   |                  |
| Tolerance band  | ±2.5 % LEL   |                        |                               |   |                  |                           |            |   |                  |
| Setting time  | t <sub>50</sub> ≤ 20 sec t <sub>90</sub> ≤ 50 sec @ CH <sub>4</sub> (Methane)  |                        |                               |   |                  |                           |            |   |                  |
| Pressure 70...130 kPa:<br>compensated (uncompensated)     | <0.18 % (1.4 %) of the CH <sub>4</sub> display per 1 % pressure change<br>(relating to 100 kPa)  |                        |                               |   |                  |                           |            |   |                  |
| Humidity 0 %...95 % RH:                                   | max. ±2.0 % LEL or ±15 % of the display (relating to 0 % RH @40 °C)  |                        |                               |   |                  |                           |            |   |                  |
| Temperature -20...+50 °C:                                 | max. ±2.0 % LEL or ±10 % of the display (relating to 20 °C)  |                        |                               |   |                  |                           |            |   |                  |
| Cross sensitivities <sup>[#]</sup> @ 50 % LEL:            | <table border="0"> <tr> <td><u>Gas application</u></td> <td><u>CH<sub>4</sub> display</u></td> </tr> <tr> <td>0.85 vol% C<sub>3</sub>H<sub>8</sub></td> <td>approx. xx % LEL</td> </tr> <tr> <td>2.20 vol% CH<sub>4</sub></td> <td>= 50 % LEL</td> </tr> <tr> <td>1.15 vol% C<sub>2</sub>H<sub>2</sub></td> <td>approx. xx % LEL</td> </tr> </table> <p>These specifications may vary from sensor to sensor and depend on the gas concentration.</p> | <u>Gas application</u> | <u>CH<sub>4</sub> display</u> | 0.85 vol% C <sub>3</sub> H <sub>8</sub> | approx. xx % LEL | 2.20 vol% CH <sub>4</sub> | = 50 % LEL | 1.15 vol% C <sub>2</sub> H <sub>2</sub> | approx. xx % LEL |
| <u>Gas application</u>                                    | <u>CH<sub>4</sub> display</u>  |                        |                               |   |                  |                           |            |   |                  |
| 0.85 vol% C <sub>3</sub> H <sub>8</sub>                   | approx. xx % LEL   |                        |                               |   |                  |                           |            |   |                  |
| 2.20 vol% CH <sub>4</sub>                                 | = 50 % LEL   |                        |                               |   |                  |                           |            |   |                  |
| 1.15 vol% C <sub>2</sub> H <sub>2</sub>                   | approx. xx % LEL   |                        |                               |   |                  |                           |            |   |                  |
| Expected service life                                     | <b>6 years</b>   |                        |                               |   |                  |                           |            |   |                  |

| <b>MK239-1 IR sensor for combustible gases and vapors</b> |   |   |   |   |   |   |                  |            |                  |                           |            |                  |                  |  |                  |                  |            |
|---|---|---|---|---|---|---|------------------|------------|------------------|---------------------------|------------|------------------|------------------|--|------------------|------------------|------------|
| Measuring range   | 0.0...100 % LEL   |   |   |   |   |   |                  |            |                  |                           |            |                  |                  |  |                  |                  |            |
| Resolution  | 0.5 % LEL   |   |   |   |   |   |                  |            |                  |                           |            |                  |                  |  |                  |                  |            |
| Tolerance band  | ±2.5 % LEL  |   |   |   |   |   |                  |            |                  |                           |            |                  |                  |  |                  |                  |            |
| Setting time  | t <sub>50</sub> ≤ 20 sec t <sub>90</sub> ≤ 50 sec @ CH <sub>4</sub> (Methane)<br>t <sub>50</sub> ≤ 20 sec t <sub>90</sub> ≤ 40 sec @ C <sub>3</sub> H <sub>8</sub> (Propane)<br>t <sub>50</sub> ≤ 20 sec t <sub>90</sub> ≤ 50 sec @ C <sub>2</sub> H <sub>2</sub> (Acetylene)   |   |   |   |   |   |                  |            |                  |                           |            |                  |                  |  |                  |                  |            |
| Pressure 70...130 kPa:<br>compensated(uncompensated)      | <0.18 % (1.4 %) of the CH <sub>4</sub> display per 1 % pressure change<br>(relating to 100 kPa)<br><0.07 % (1.6 %) of the C <sub>3</sub> H <sub>8</sub> display per 1 % pressure change<br>(relating to 100 kPa)<br><0.28 % (2.6 %) of the C <sub>2</sub> H <sub>2</sub> display per 1 % pressure change<br>(relating to 100 kPa)   |   |   |   |   |   |                  |            |                  |                           |            |                  |                  |  |                  |                  |            |
| Humidity 0 %...95 % RH:                                   | max. ±2.0 % LEL or ±15 % of the display (relating to 0 % RH @40 °C)   |   |   |   |   |   |                  |            |                  |                           |            |                  |                  |  |                  |                  |            |
| Temperature -20...+50 °C:                                 | max. ±2.0 % LEL or ±10 % of the display (relating to 20 °C)   |   |   |   |   |   |                  |            |                  |                           |            |                  |                  |  |                  |                  |            |
| Cross sensitivities <sup>[#]</sup> @ 50 % LEL:            | <table border="0"> <tr> <td><u>Gas application</u></td> <td><u>CH<sub>4</sub> display</u></td> <td><u>C<sub>3</sub>H<sub>8</sub> display</u></td> <td><u>C<sub>2</sub>H<sub>2</sub> display</u></td> </tr> <tr> <td>0.85 vol% C<sub>3</sub>H<sub>8</sub></td> <td>approx. xx % LEL</td> <td>= 50 % LEL</td> <td>approx. xx % LEL</td> </tr> <tr> <td>2.20 vol% CH<sub>4</sub></td> <td>= 50 % LEL</td> <td>approx. xx % LEL</td> <td>approx. xx % LEL</td> </tr> <tr> <td>1.5 vol% C<sub>2</sub>H<sub>2</sub></td> <td>approx. xx % LEL</td> <td>approx. xx % LEL</td> <td>= 50 % LEL</td> </tr> </table> <p>These specifications may vary from sensor to sensor and depend on the gas concentration.</p> | <u>Gas application</u>                    | <u>CH<sub>4</sub> display</u>             | <u>C<sub>3</sub>H<sub>8</sub> display</u> | <u>C<sub>2</sub>H<sub>2</sub> display</u> | 0.85 vol% C <sub>3</sub> H <sub>8</sub> | approx. xx % LEL | = 50 % LEL | approx. xx % LEL | 2.20 vol% CH <sub>4</sub> | = 50 % LEL | approx. xx % LEL | approx. xx % LEL | 1.5 vol% C <sub>2</sub> H <sub>2</sub> | approx. xx % LEL | approx. xx % LEL | = 50 % LEL |
| <u>Gas application</u>                                    | <u>CH<sub>4</sub> display</u>   | <u>C<sub>3</sub>H<sub>8</sub> display</u> | <u>C<sub>2</sub>H<sub>2</sub> display</u> |   |   |   |                  |            |                  |                           |            |                  |                  |  |                  |                  |            |
| 0.85 vol% C <sub>3</sub> H <sub>8</sub>                   | approx. xx % LEL  | = 50 % LEL                                | approx. xx % LEL                          |   |   |   |                  |            |                  |                           |            |                  |                  |  |                  |                  |            |
| 2.20 vol% CH <sub>4</sub>                                 | = 50 % LEL  | approx. xx % LEL                          | approx. xx % LEL                          |   |   |   |                  |            |                  |                           |            |                  |                  |  |                  |                  |            |
| 1.5 vol% C <sub>2</sub> H <sub>2</sub>                    | approx. xx % LEL  | approx. xx % LEL                          | = 50 % LEL                                |   |   |   |                  |            |                  |                           |            |                  |                  |  |                  |                  |            |
| Expected service life                                     | <b>6 years</b>  |   |   |   |   |   |                  |            |                  |                           |            |                  |                  |  |                  |                  |            |

| <b>MK238-1 IR sensor for combustible gases and vapors</b> |  |                        |   |   |            |                           |                  |   |                  |
|---|--|------------------------|---|---|------------|---------------------------|------------------|---|------------------|
| Measuring range   | 0.0...100 % LEL  |                        |   |   |            |                           |                  |   |                  |
| Resolution  | 0.5 % LEL  |                        |   |   |            |                           |                  |   |                  |
| Tolerance band  | ±2.5 % LEL   |                        |   |   |            |                           |                  |   |                  |
| Setting time  | t <sub>50</sub> ≤ 20 sec t <sub>90</sub> ≤ 40 sec @ C <sub>3</sub> H <sub>8</sub> (Propane)  |                        |   |   |            |                           |                  |   |                  |
| Pressure 70...130 kPa:<br>compensated (uncompensated)     | <0.07 % (1.6 %) of the C <sub>3</sub> H <sub>8</sub> display per 1 % pressure change<br>(relating to 100 kPa)  |                        |   |   |            |                           |                  |   |                  |
| Humidity 0 %...95 % RH:                                   | max. ±2.0 % LEL or ±15 % of the display (relating to 0 % RH @40 °C)  |                        |   |   |            |                           |                  |   |                  |
| Temperature -20...+50 °C:                                 | max. ±2.0 % LEL or ±10 % of the display (relating to 20 °C)  |                        |   |   |            |                           |                  |   |                  |
| Cross sensitivities <sup>[#]</sup> @ 50 % LEL:            | <table border="0"> <tr> <td><u>Gas application</u></td> <td><u>C<sub>3</sub>H<sub>8</sub> display</u></td> </tr> <tr> <td>0.85 vol% C<sub>3</sub>H<sub>8</sub></td> <td>= 50 % LEL</td> </tr> <tr> <td>2.20 vol% CH<sub>4</sub></td> <td>approx. xx % LEL</td> </tr> <tr> <td>1.15 vol% C<sub>2</sub>H<sub>2</sub></td> <td>approx. xx % LEL</td> </tr> </table> <p>These specifications can vary from sensor to sensor and depend on the gas concentration.</p> | <u>Gas application</u> | <u>C<sub>3</sub>H<sub>8</sub> display</u> | 0.85 vol% C <sub>3</sub> H <sub>8</sub> | = 50 % LEL | 2.20 vol% CH <sub>4</sub> | approx. xx % LEL | 1.15 vol% C <sub>2</sub> H <sub>2</sub> | approx. xx % LEL |
| <u>Gas application</u>                                    | <u>C<sub>3</sub>H<sub>8</sub> display</u>  |                        |   |   |            |                           |                  |   |                  |
| 0.85 vol% C <sub>3</sub> H <sub>8</sub>                   | = 50 % LEL   |                        |   |   |            |                           |                  |   |                  |
| 2.20 vol% CH <sub>4</sub>                                 | approx. xx % LEL   |                        |   |   |            |                           |                  |   |                  |
| 1.15 vol% C <sub>2</sub> H <sub>2</sub>                   | approx. xx % LEL   |                        |   |   |            |                           |                  |   |                  |
| Expected service life                                     | <b>6 years</b>   |                        |   |   |            |                           |                  |   |                  |

| <b>MK237-1 IR sensor for combustible gases and vapors</b> |  |                        |                               |   |                  |                           |            |   |                  |
|---|--|------------------------|-------------------------------|---|------------------|---------------------------|------------|---|------------------|
| Measuring range   | 0.0...100 % LEL  |                        |                               |   |                  |                           |            |   |                  |
| Resolution  | 0.5 % LEL  |                        |                               |   |                  |                           |            |   |                  |
| Tolerance band  | ±2.5 % LEL   |                        |                               |   |                  |                           |            |   |                  |
| Setting time  | t <sub>50</sub> ≤ 20 sec t <sub>90</sub> ≤ 50 sec @ CH <sub>4</sub> (Methane)  |                        |                               |   |                  |                           |            |   |                  |
| Pressure 70...130 kPa:<br>compensated (uncompensated)     | <0.18 % (1.4 %) of the CH <sub>4</sub> display per 1 % pressure change<br>(relating to 100 kPa)  |                        |                               |   |                  |                           |            |   |                  |
| Humidity 0 %...95 % RH:                                   | max. ±2.0 % LEL or ±15 % of the display (relating to 0 % RH @40 °C)  |                        |                               |   |                  |                           |            |   |                  |
| Temperature -20...+50 °C:                                 | max. ±2.0 % LEL or ±10 % of the display (relating to 20 °C)  |                        |                               |   |                  |                           |            |   |                  |
| Cross sensitivities <sup>[#]</sup> @ 50 % LEL:            | <table border="0"> <tr> <td><u>Gas application</u></td> <td><u>CH<sub>4</sub> display</u></td> </tr> <tr> <td>0.85 vol% C<sub>3</sub>H<sub>8</sub></td> <td>approx. xx % LEL</td> </tr> <tr> <td>2.20 vol% CH<sub>4</sub></td> <td>= 50 % LEL</td> </tr> <tr> <td>1.15 vol% C<sub>2</sub>H<sub>2</sub></td> <td>approx. xx % LEL</td> </tr> </table> <p>These specifications may vary from sensor to sensor and depend on the gas concentration.</p> | <u>Gas application</u> | <u>CH<sub>4</sub> display</u> | 0.85 vol% C <sub>3</sub> H <sub>8</sub> | approx. xx % LEL | 2.20 vol% CH <sub>4</sub> | = 50 % LEL | 1.15 vol% C <sub>2</sub> H <sub>2</sub> | approx. xx % LEL |
| <u>Gas application</u>                                    | <u>CH<sub>4</sub> display</u>  |                        |                               |   |                  |                           |            |   |                  |
| 0.85 vol% C <sub>3</sub> H <sub>8</sub>                   | approx. xx % LEL   |                        |                               |   |                  |                           |            |   |                  |
| 2.20 vol% CH <sub>4</sub>                                 | = 50 % LEL   |                        |                               |   |                  |                           |            |   |                  |
| 1.15 vol% C <sub>2</sub> H <sub>2</sub>                   | approx. xx % LEL   |                        |                               |   |                  |                           |            |   |                  |
| Expected service life                                     | <b>6 years</b>   |                        |                               |   |                  |                           |            |   |                  |

## Internal parameter memory of the IR 29 transmitter

Each IR 29 transmitter is preprogrammed with the data of the most important gases and their additional parameters. Therefore, users should not find it necessary to change the configuration. The following information is stored in the internal memory of the transmitter:

| <b>Gas type</b> | <b>Formula</b>                | <b>Unit</b> | <b>CGAS<br/>Calibration<br/>gas<br/>in vol%</b> |
|-----------------|-------------------------------|-------------|---|
| Methane         | CH <sub>4</sub>               | % LEL       | 2.2   |
| Propane         | C <sub>3</sub> H <sub>8</sub> | % LEL       | 0.85  |
| Acetylene       | C <sub>2</sub> H <sub>2</sub> | % LEL       | 1.15  |

## Technical data

|  |  |
|--|--|
| <b>Device types</b>  | IR 29 i and IR 29 Di   |
| <b>Measuring function</b><br>Measuring method:<br>Output signal:   | IR absorption<br>4..20 mA (max. resistance: 340 Ω @ 15 V or 740 Ω @ 24 V)<br>(max. resistance at GfG SB1: 270 Ω @ 22 V-30 V))  |
| <b>Power supply</b><br>Voltage supply:<br>Voltage supply SB1:  | 15..30 V DC @intrinsically safe supply<br>22..30 V DC @supply via GfG SB1  |
| <b>Climatic conditions</b><br>For storage:<br>For operation:<br>Air pressure:<br>Humidity:   | -25..+60 °C (recommended 0...+30 °C)<br>-20..+55 °C (also see sensor specification)<br>0..200 kPa (also see sensor specification)<br>0..100 % RH (non-condensing)  |
| <b>Housing</b><br>Protection class:<br>Material:<br>Weight:<br>Dimensions:   | IP67<br>Stainless steel, polycarbonate, PA, POM<br>approximately 950 g<br>6.3386 inches x 2.9528 inches / 161 mm x 75 mm (L x 0); mounting surface at least 6.3386 inches x 5.2362 inches / 161 mm x 133 mm; Height 4.6457 inches / 118 mm |
| <b>Approvals and inspections</b><br>Certification:<br>Ignition protection class:<br>EC Type Examination Certificate:   |  II 1G 0158<br>Ex ia IIC T4 Ga -20 °C ≤ Ta ≤ +55 °C<br>BVS 09 ATEX E 135 X  |
| Electrical parameters for the intrinsically safe connection  |  |
| Intrinsically safe supply circuit:<br>Maximum input voltage:<br>Maximum internal capacity:<br>Maximum internal inductance:   | Connection via terminals X1 and X2<br>Ui DC 30 V<br>Ci 11 nF<br>Li negligible  |
| Intrinsically safe signal circuit:<br>Maximum input voltage:<br>Maximum internal capacity:<br>Maximum internal inductance:   | Connection via terminals X3 and X4<br>Ui DC 30 V<br>Ci 1.8 nF<br>Li negligible   |
| The intrinsically safe signal circuit is galvanically separated from the intrinsically safe supply circuit up to a sum of the maximum values of the nominal voltage of 60 V. |  |

Drilling template M1:1

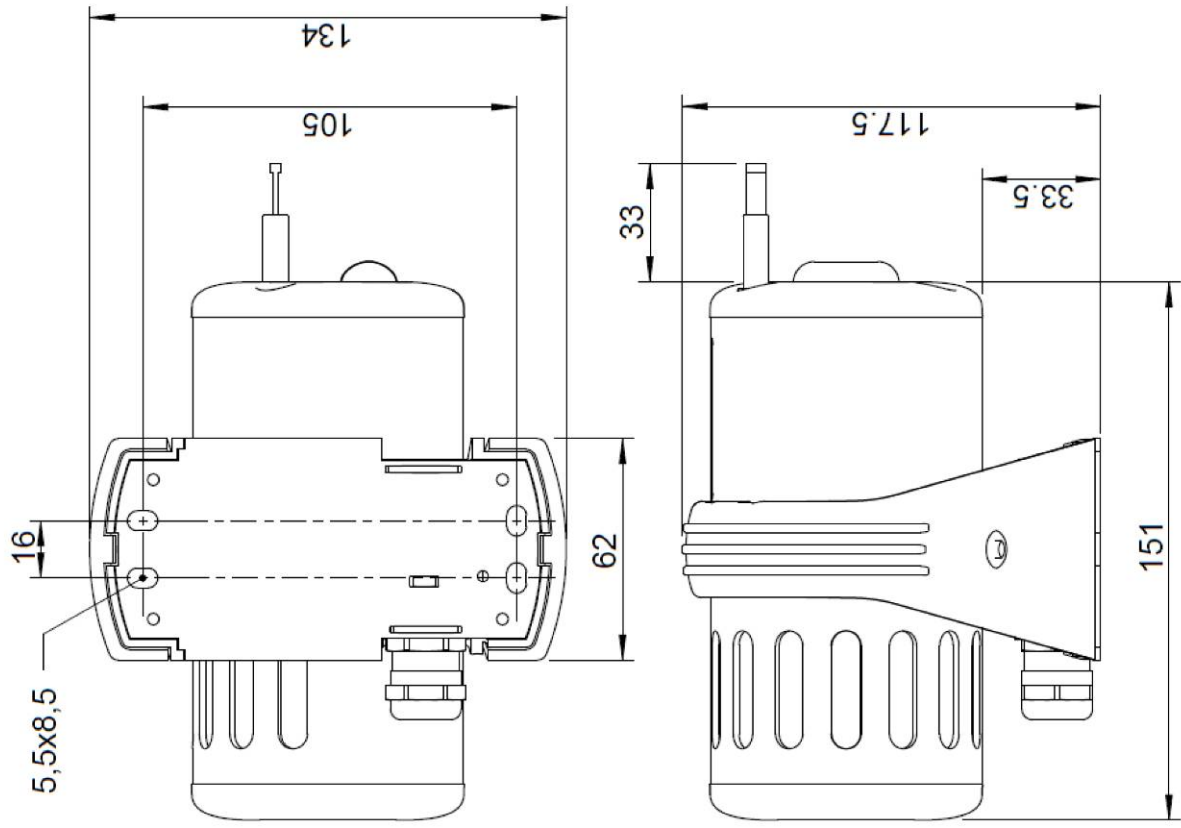

## Appendix RC 3

### Application and purpose

The RC 3 remote control can only be used for operating and checking, or calibrating and adjusting the zero point and the sensitivity of the IR 29 transmitters with a display.

The RC 3 remote control is powered by a lithium battery, which should not be replaced in potentially explosive atmospheres.

The RC 3 remote control has been approved for application in potentially explosive atmospheres and has an EC Type Examination Certification issued by DEKRA EXAM GmbH, in accordance with Directive 94/9/EC (ATEX100a) with the following

Certificate: BVS 08 ATEX E 006

Certification:  I M1 Ex ia I Ma

 II 1G Ex ia IIC T6 Ga  $-20^{\circ}\text{C} \leq T_a \leq +55^{\circ}\text{C}$

### Operation

The button assignment of the RC 3 can be shown on the display of the device by briefly pressing the central button.

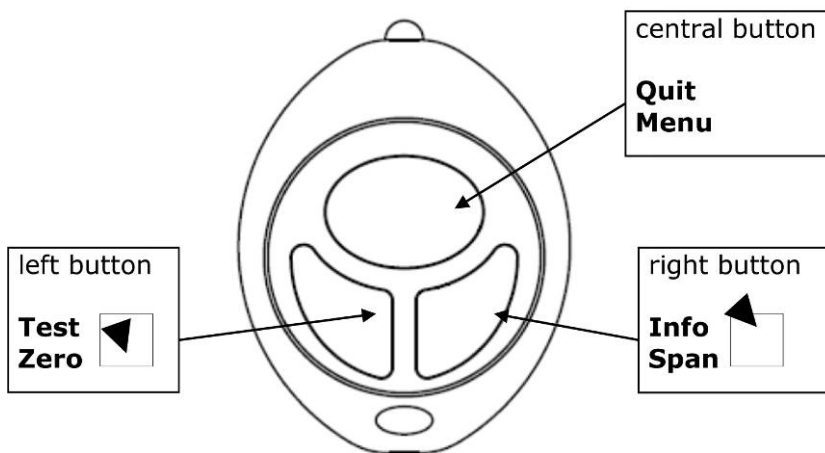

**The receiver software only responds to activations >0.6 sec. to avoid unintentional or incorrect operation.**

### Channel coding

The RC 3 has been coded to channel 16 from the factory. Each IR 29 transmitter can be operated with this code.

If desired, channels 1-15 can be coded in the RC 3 from the factory. The IR 29 transmitter must be set to the same channel. This can be carried out by the user and is reversible. This ensures the grouping of devices which can only be operated with a separate channel.

The RC 2 remote control is not influenced by these settings.

## Changing batteries





### The Caution!

Never open the device in potentially explosive atmospheres to change the lithium battery.

When inserting the new lithium batteries, always observe their polarity. These batteries should only be obtained from the manufacturer, GfG Instrumentation. Internal monitoring ensures that only batteries which meet the demands of the Type Examination are used. The battery type is: **VARTA CR 2430**.

## Technical data

|  |   |
|--|---|
| <b>Type designation</b>  | RC 3  |
| <b>Climatic conditions</b><br>For operation:   | -20..+55 °C   5..95 % RH   700..1300 hPa  |
| <b>Power supply</b>  | Lithium battery type: VARTA CR 2430<br>U <sub>n</sub> =3 V C=280 mAh  |
| <b>Housing</b><br>Protection class:<br>Material:<br>Weight:<br>Dimensions:   | Min. IP20<br>Plastic<br>20 g<br>1.7323 inches x 2.4016 inches x .59055 inches / 44 mm x 61 mm x 15 mm (W x H x D)   |
| <b>Approvals and inspections</b><br>Certification and ignition:<br>protection class:<br>EC Type Examination Certificate: |  I M1 Ex ia I Ma<br> II 1G Ex ia IIC T6 Ga -20 °C ≤ Ta ≤ +55 °C<br>BVS 08 ATEX E 006 (without measuring function) |

## Appendix SB1 / SB1D

### Operating instructions

The SB1 and SB1D transmitter supply modules are used to limit the voltage and the current of non-intrinsically safe circuits to intrinsically safe values. The non-intrinsically safe circuits are galvanically connected to the intrinsically safe circuits.

An IR 29 transmitter connected to the SB1 transmitter supply module is supplied in an intrinsically safe manner. Signals of the IR 29 transmitter are read through a 4-20 mA interface and transferred to a controller located outside a potentially explosive atmosphere. The transmitter supply module is optionally equipped with a display for the local display of measured values (type SB1D) of the respectively connected IR 29 transmitter.

The transmitter supply modules have been optimally designed for the supply of the IR 29i and IR 29 Di transmitters.

The SB1 and SB1D transmitter supply modules must be installed outside a potentially explosive atmosphere and have an EC Type Examination Certificate issued by DEKRA EXAM GmbH in accordance with Directive 94/9/EC.

The following applies to SB1 and SB1D:

Certificate: BVS 11 ATEX E 164

Certification:  II (1) G [Ex ia Ga] IIC -20°C ≤ Ta ≤ +55°C

### Device design

Please refer to the table "Technical data" for the maximum values of the voltage, current and power in the intrinsically safe circuits ( $U_0$ ,  $I_0$ ,  $P_0$ ) as well as the maximum permissible values of the connected capacities and inductances ( $C_0$  und  $L_0$ ). The values listed in the table apply to one of the two barrier branches that must be observed separately (relating to PA). Observe the current or voltage additions when interconnecting.

### Installing electrical connections

Input circuit (terminals X1, X2 and X3) Only for connection to a non-intrinsically safe circuit with a safety-related maximum voltage of  $U_m = 253 \text{ V AC}$

Output circuit (terminals X4 and X5) In ignition protection class 'intrinsically safe' [Ex ia Ga]  
Characteristics of the circuits: linear (see Technical data)

Signal circuit (terminals X6 and X7) In ignition protection class 'intrinsically safe' [Ex ia Ga]  
Characteristics of the circuits: linear (see Technical data)

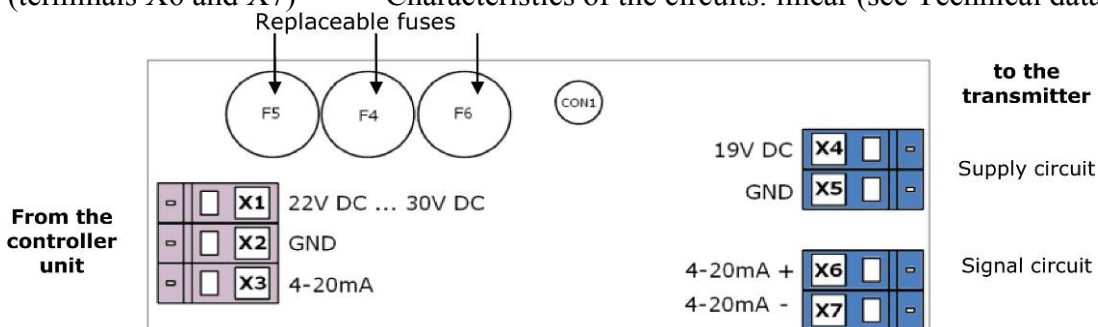



The transmitter supply module is equipped with three exchangeable pre-fuses. When replacing the fuses, ensure that only fuse type 164050.0,063(IN=63mA) from SIBA is used (see Technical data)

As the intrinsically safe circuits are galvanically connected to the earth potential, the ground connection must be provided throughout the entire intrinsically safe circuits.

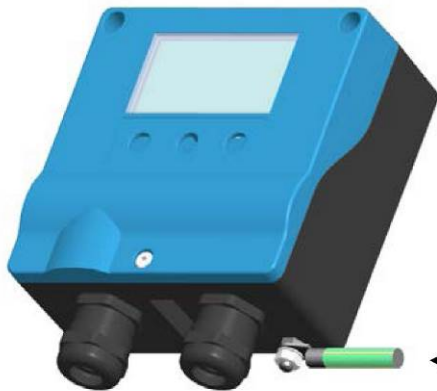

**Ground connection:**

Located next to the cable glands on the bottom side.

The ground connection must take place with a line cross section of 4 mm<sup>2</sup>.

← Ground connection

## Technical data

|   |  |
|---|--|
| <b>Device types</b>   | SB1 and SB1D   |
| <b>Power supply</b>   | Voltage supply: 22 V DC..30 V DC   |
| <b>Climatic conditions</b>                                      | For storage: -25..+60 °C (recommended 0...+30 °C)<br>For operation: -20..+55 °C<br>Air pressure: 0..200 kPa<br>Humidity: 0..100 % RH (non-condensing)  |
| <b>Housing</b>  | Protection class: IP54<br>Material: ABS<br>Weight: approximately 300 g<br>Dimensions: 3.8583 inches x 3.7795 inches x 1.8898 inches / 98 mm x 96 mm x 48 mm (L x W x H) without cable gland  |
| <b>Replaceable pre-fuses</b>                                    | Type: 164050.0.063<br>Rated current: 63 mA<br>Rated breaking capacity: 35 A @ 250 V AC<br>Melting integral (I <sup>2</sup> t <sub>s</sub> ): 0.0007<br>Inspected according to: IEC 60127<br>Manufacturer: SIBA                       |
| <b>Approvals and inspections</b>                                | Certification:  II(1)G 0158<br>Ignition protection class: [Ex ia Ga] IIC -20 °C ≤ Ta ≤ +55 °C<br>EC Type Examination Certificate: BVS 11 ATEX E 164 |
| Electrical parameters for the non-intrinsically safe connection |  |
| Non-intrinsically safe supply circuit:                          | X1: +22 V DC ... 30 V DC ...<br>X2: GND  |
| Non-intrinsically safe signal circuit:                          | X3: 4-20 mA  |
| Maximum error voltage:  | Um 253 V AC  |
| Electrical parameters for the intrinsically safe connection     |  |
| Intrinsically safe supply circuit:                              | X4: +19 V DC ...<br>X5: GND  |
| Maximum output voltage:   | U <sub>0</sub> 21 V DC   |
| Maximum output current:   | I <sub>0</sub> 161 mA DC   |
| Maximum output rating:  | P <sub>0</sub> 844 mW  |
| Maximum connectible capacity:                                   | C <sub>0</sub> 180 nF  |
| Maximum connectible inductance:                                 | L <sub>0</sub> 1 mH  |
| Intrinsically safe signal circuit:                              | X6: 4-20 mA +<br>X7: 4-20 mA -   |
| Maximum output voltage:   | U <sub>0</sub> 21 V DC   |
| Maximum output current:   | I <sub>0</sub> 161 mA DC   |
| Maximum output rating:  | P <sub>0</sub> 844 mW  |
| Maximum connectible capacity:                                   | C <sub>0</sub> 180 nF  |
| Maximum connectible inductance:                                 | L <sub>0</sub> 1 mH  |



(1) **1. Nachtrag zur EG-Baumusterprüfbescheinigung**

(2) Geräte und Schutzsysteme zur bestimmungsgemäßen Verwendung in explosionsgefährdeten Bereichen - Richtlinie 94/9/EG Ergänzung gemäß Anhang III Ziffer 6

(3) Nr. der EG-Baumusterprüfbescheinigung: **BVS 09 ATEX E 135 X**

(4) Gerät: **Transmitter Typ IR29 i und Typ IR29 Di**

(5) Hersteller: **GfG Gesellschaft für Gerätebau mbH**

(6) Anschrift: **44143 Dortmund**

(7) Die Bauart dieser Geräte sowie die verschiedenen zulässigen Ausführungen sind in der Anlage zu diesem Nachtrag festgelegt.

(8) Die Zertifizierungsstelle der DEKRA EXAM GmbH, benannte Stelle Nr. 0158 gemäß Artikel 9 der Richtlinie 94/9/EG des Europäischen Parlaments und des Rates vom 23. März 1994, bescheinigt, dass diese Geräte die grundlegenden Sicherheits- und Gesundheitsanforderungen für die Konzeption und den Bau von Geräten und Schutzsystemen zur bestimmungsgemäßen Verwendung in explosionsgefährdeten Bereichen gemäß Anhang II der Richtlinie erfüllen. Die Ergebnisse der Prüfung sind in dem Prüfprotokoll BVS PP 10.2190 EG niedergelegt.

(9) Die grundlegenden Sicherheits- und Gesundheitsanforderungen werden erfüllt durch Übereinstimmung mit:

- EN 60079-0:2009 **Allgemeine Anforderungen**
- EN 60079-11:2007 **Eigensicherheit '1'**
- EN 60079-26:2007 **Betriebsmittel mit Geräteschutzniveau (EPL) Ga**

(10) Falls das Zeichen "X" hinter der Bescheinigungsnummer steht, wird in der Anlage zu dieser Bescheinigung auf besondere Bedingungen für die sichere Anwendung des Gerätes hingewiesen.

(11) Dieser Nachtrag zur EG-Baumusterprüfbescheinigung bezieht sich nur auf die Konzeption und die Baumusterprüfung der beschriebenen Geräte in Übereinstimmung mit der Richtlinie 94/9/EG. Für Herstellung und Inverkehrbringen der Geräte sind weitere Anforderungen der Richtlinie zu erfüllen, die nicht durch diese Bescheinigung abgedeckt sind.

(12) Die Kennzeichnung des Gerätes muss die folgenden Angaben enthalten:

 **II 1G Ex ia IIC T4 Ga**

DEKRA EXAM GmbH  
Bochum, den 27.09.2011

  
\_\_\_\_\_  
Zertifizierungsstelle

  
\_\_\_\_\_  
Fachbereich

- (13) Anlage zum
- (14) **1. Nachtrag zur EG-Baumusterprüfbescheinigung BVS 09 ATEX E 135 X**

(15) 15.1 Gegenstand und Typ

Transmitter Typ IR29 \*\*\*

Der Transmitter Typ IR29 \*\*\* wird nur noch nach den im zugehörigen Prüfprotokoll aufgeführten Prüfungsunterlagen gefertigt und erhält dann die Benennung **Typ IR29 i** oder **Typ IR29 Di** (Details siehe Tabelle).

| Typ     | Kennzeichnung         | Anschlussvariante / Funktionalität |
|---------|-----------------------|------------------------------------|
| IR29 i  | II 1G Ex ia IIC T4 Ga | 4-20 mA (eigensicher)              |
| IR29 Di | II 1G Ex ia IIC T4 Ga | 4-20 mA (eigensicher), mit Display |

15.2 Beschreibung

Die eigensicheren Transmitter Typ IR29 i und Typ IR29 Di dienen stationär zur Messung von toxischen und brennbaren Gasen (IR-Sensor) unter atmosphärischen Bedingungen.

Die elektronische Schaltung der Transmitter befindet sich auf Isolierstoffplatten, die in einem Metall-/Kunststoffgehäuse gesichert befestigt sind. Die Isolierstoffplatten sind teilweise vergossen.

Der Anschluss des eigensicheren Versorgungsstromkreises und des eigensicheren Signalstromkreises (4-20 mA) erfolgt über Klemmen.

Die Transmitter verfügen zusätzlich über einen 4-poligen Steckverbinder an dem ausschließlich das Bediengerät Typ RC2 (BVS 04 ATEX E212) zur Parametrierung angeschlossen werden darf.

Die Transmitter sind zum Einsatz in einem Umgebungstemperaturbereich von -20 °C bis +55 °C geeignet.

15.3 Kenngrößen

15.3.1 Eigensicherer Versorgungsstromkreis, Anschluss über Klemmen X1 und X2

|                              |       |                  |
|------------------------------|-------|------------------|
| Maximale Eingangsspannung    | $U_i$ | DC 30 V          |
| Maximale innere Kapazität    | $C_i$ | 11 nF            |
| Maximale innere Induktivität | $L_i$ | vernachlässigbar |

15.3.2 Eigensicherer Signalstromkreis (4-20 mA), Anschluss über Klemmen X3 und X4

|                              |       |                  |
|------------------------------|-------|------------------|
| Maximale Eingangsspannung    | $U_i$ | DC 30 V          |
| Maximale innere Kapazität    | $C_i$ | 1,8 nF           |
| Maximale innere Induktivität | $L_i$ | vernachlässigbar |

Der eigensichere Signalstromkreis ist von dem eigensicheren Versorgungsstromkreis bis zu einer Summe der Scheitelwerte der Nennspannungen von 60 V sicher galvanisch getrennt.

15.3.3 Eigensichere potentialfreie Optokopplerschnittstelle, Anschluss über 4-poligen Steckverbinder  
Nur zur Anschaltung des Bediengerätes Typ RC2 (BVS 04 ATEX E212)

15.3.4 Umgebungstemperaturbereich -20 °C bis +55 °C

(16) Prüfprotokoll

BVS PP 10.2190 EG, Stand 27.09.2011

(17) Besondere Bedingungen für die sichere Anwendung

Die Messfunktion für den Explosionsschutz ist nicht Gegenstand dieser EG-Baumusterprüfbescheinigung.

## EG- Konformitätserklärung

**GfG Gesellschaft für Gerätebau mbH**

**IR29 i, IR29 Di**

Klönnersrasse 98  
44143 Dortmund  
Tel: +49 (231) 56400-0  
Fax: +49 (231) 516313  
E-Mail: info@gfg-mbh.com  
www.gfgmessung.de  
[www.gfg.biz](http://www.gfg.biz)



Erstellt: 03.08.2010

Geändert: 05.08.2012

[www.gfg.biz](http://www.gfg.biz)

Die GfG Gesellschaft für Gerätebau mbH entwickelt, produziert und vertreibt Gassensoren und Gaswarnanlagen unter Anwendung eines **Qualitätsmanagementsystems** nach DIN EN ISO 9001.

Überwacht wird die Produktion von elektrischen Betriebsmitteln der Gerätegruppen I und II, Kategorien M1, M2, 1G und 2G für Gassensoren, Gasmessgeräte, Gaswarnanlagen in den Zündschutzarten Druckfeste Kapselung, Erhöhte Sicherheit, Vergusskapselung und Eigensicherheit mit deren Messfunktion mit Hilfe eines **Qualitätssicherungssystems** Zertifikats- Nr. BVS 03 ATEX ZQS / E 187 - durch die benannte Stelle, DEKRA EXAM GmbH.

Der Transmitter **IR29 i, IR29 Di** entspricht der **Richtlinie 94/9/EG** für Geräte und Schutzsysteme zur bestimmungsgemäßen Verwendung in explosionsgefährdeten Bereichen (ATEX- Richtlinie) und der **Richtlinie 2004/108/EG** für die elektromagnetische Verträglichkeit.

### Für den elektrischen Explosionsschutz Kennzeichnung

BVS 09 ATEX E 135 X  
Ⓔ II **1G** Ex ia IIC T4 Ga  
Ⓔ I **M1** Ex ia I Ma  
CE 0158

Die Richtlinien wurden unter Berücksichtigung der folgenden Normen eingehalten:

#### - Elektrischer Explosionsschutz

- Elektrische Betriebsmittel für explosionsgefährdete Bereiche.  
Allgemeine Bestimmungen EN 60079-0
- Eigensicherheit „i“ EN 60079-11
- Gerätegruppe Kategorie 1G EN 60079-26
- Gruppe 1. Kategorie-M1-Geräte EN 50303

#### - Elektromagnetische Verträglichkeit

- Elektrische Geräte für die Detektion und Messung von brennbaren Gasen, toxischen Gasen und Sauerstoff. EN 50270
- Störaussendung: Typklasse 1
- Störfestigkeit: Typklasse 2

Die Bewertung der grundlegenden Sicherheits- und Gesundheitsanforderungen wurden vor der notifizierten Stelle mit der Kenn- Nr. 0158 ( DEKRA EXAM GmbH, Dinnendahlstraße 9 D-44809 Bochum ) vorgenommen, dokumentiert und hinterlegt. Mit der Prüfung und Bewertung der elektromagnetischen Verträglichkeit wurde das EMV Messlabor EM TEST GmbH, D-59174 Kamen beauftragt.

Die Sicherheitshinweise in der Betriebsanleitung 224-000.20 sind zu beachten.

Dortmund, den 05. Juni 2012

.....  
Dipl. Kfm. H.J. Höbre  
Geschäftsführer





## **GfG Instrumentation, Inc.**

1194 Oak Valley Dr.  
Suite 20  
Ann Arbor, MI 48108  
USA

US/Canada: (800) 959-0329  
US/Canada Fax: (734) 769-1888  
International: +1 734 769 0573  
International Fax: +1 734 769 1888  
E-mail: [info@goodforgas.com](mailto:info@goodforgas.com)  
Website: [www.goodforgas.com](http://www.goodforgas.com)

GfG reserves the right to change part numbers, prices, and/or technical information without notification.



**GfG Instrumentation**  
Worldwide Manufacturer of Gas Detection Solutions

7004-029 Rev. 3 (01/17/18)