



# GfG Instrumentation

Worldwide manufacturer of gas detection solutions

# IR 22

## Operations Manual



## GfG Instrumentation

1194 Oak Valley Dr, Ste 20, Ann Arbor MI 48108 USA

(800) 959-0329 • (734) 769-0573 • [www.goodforgas.com](http://www.goodforgas.com)



# Table of contents

	<b>Page</b>
<b>1. INTRODUCTION</b>	<b>3</b>
1.1 For your safety	3
1.2 Operating notes	3
<b>2. GENERAL INFORMATION ABOUT THE TRANSMITTER</b>	<b>4</b>
2.1 General description	4
2.2 Measurement method	4
2.3 Transmission behavior	4
2.4 Equipment configuration	5
<b>3. ASSEMBLY AND INSTALLATION INSTRUCTIONS</b>	<b>6</b>
3.1 Site of installation	6
3.2 Assembly	6
3.3 Installing electrical connections	6
<b>4. OPERATING INSTRUCTIONS</b>	<b>7</b>
4.1 Commissioning	7
4.2 Measuring mode	8
4.2.1 Exceeding the measuring range	8
4.2.2 Under range measuring signal	9
4.2.3 Operating keys – Display models	9
4.2.4 Display, LED and horn test [TEST]	9
4.2.5 Display of operating parameters [INFO]	9
4.2.6 Sensor service life	9
4.3 Calibration and adjustment	10
4.3.1 Zero point calibration	10
4.3.2 Zero point adjustment with display and keyboard [ZERO]	10
4.3.3 Zero point adjustment with the AutoCal button [ZERO]	10
4.3.4 Zero point adjustment with the ZERO-Pot	11
4.3.5 Sensitivity calibration	11
4.3.6 Sensitivity adjustment with display and keyboard [SPAN]	12
4.3.7 Sensitivity adjustment with the AutoCal button [SPAN]	12
4.3.8 Sensitivity adjustment with the SPAN-Pot	12
4.4 Main and service menu [MENU]	13
4.4.1 Main menu	13
4.4.2 Service menu	13
4.5 Displays and messages	15
4.5.1 Overview of the status LED conditions and current output signals	15
4.5.2 Displays of special statuses (device start and malfunction)	15
4.5.3 Displays in the service mode and for the sensor adjustment	16
4.5.4 Displays in the measuring mode	17
4.5.5 Priority of displays and messages in the measuring mode	17
4.6 Malfunction, cause, remedy	17
<b>5. APPENDIX</b>	<b>18</b>
5.1 Cleaning and care	18
5.2 Maintenance and service	18
5.2.1 Visual inspection	18
5.2.2 Functional testing	19
5.2.3 System check	19
5.2.4 Repair	19
5.3 Sensor replacement	19
5.4 Accessories and spare parts	19
5.5 Sensor specification	20
5.6 Technical data	21
5.7 Declaration of Conformity	22

# 1. INTRODUCTION

## 1.1 For your safety

These operating instructions must be read and observed by everyone who operates, services, maintains and inspects this product. This product can serve its intended purpose only if it is operated, serviced, maintained and inspected according to the instructions given by GfG Instrumentation.

The warranty assumed by GfG becomes null and void, if it is not used, cared for, maintained and controlled according to the specifications of GfG.

## 1.2 Operating notes

Inspections must be carried out in accordance with the manufacturer's instructions and executed by a fully trained and qualified expert. In Germany, it applies therefore „DGUV (German Social Accident Insurance) Information 213-056 (leaflet T 021 / up to now BGI 836 Paragraph 8.1)“ and „DGUV (German Social Accident Insurance) Information 213-057 (leaflet T 023 / up to now BGI 518 Paragraph 8.1)“.

The function and display of the transmitter has been tested before shipment. The calibration and adjustment is performed with corresponding test or calibration gases.

**This does not mean it doesn't need to be calibrated and if applicable, adjusted once installed. It must be calibrated at the final installation.**

The IR 22 transmitter is not designed to be used in explosive atmospheres.



### **CAUTION**

**The supply voltage must not exceed 30V DC!  
This also applies for voltage spikes!**

## **2. GENERAL INFORMATION ABOUT THE TRANSMITTER**

### **2.1 General description**

A stationary gas warning system consists of a transmitter and a gas measuring and analysis unit (a controller is not included but can be optionally ordered). The transmitter and controller are connected using remote cabling. The transmitter converts the gas concentration into an electrical measurement signal and sends it to the analysis unit for further processing.

Optionally, the IR 22 transmitter can be equipped with a graphic display with operating buttons and acoustic beeper. The display has a "green" backlight during the measurement operation. In case of a malfunction or fault, the display color will change to "red".

Each 22 series transmitter has been equipped with two status LEDs, which indicate the operating status of the device. A "green" LED indicates the operational readiness and a "yellow" LED signals a malfunction or a special status.

The 22 series transmitter can either be equipped with an analog current interface or with a digital RS485 interface. The current interface can output the measuring information with 4-20mA. The communication of the digital RS485 interface is performed according to the Modbus (RTU) protocol.

The transmitter distinguishes itself by:

- Concentration display (for the display model)
- Settings without opening the housing by the push of a button (for the display model)
- Compensation of temperature influences
- Status display (measurement operation, malfunction or special status) on the transmitter

### **2.2 Measurement method**

The gas sensor used in the IR 22 transmitter is an infrared sensor. Infrared sensors use the features of gases, to absorb light in certain spectral ranges. Infrared light emitted by a source of radiation crosses the measuring section with the measuring gas. With the measuring gas, a weakening of the radiation energy is taking place by absorption in a certain wavelength range. The strength of the absorption depends on the concentration of the gas to be measured and will be collected with an infrared detector. With a second infrared detector the radiation will be collected for a gas independent reference wavelength range. Since the signals collected by the two infrared detectors are not yet proportional to the gas concentration, the gas needs to be calculated by compensating different effects and linearization.

### **2.3 Transmission behavior**

Depending on the type of the measuring gas, the transmitter has different transmission properties. The reaction times may be different depending on the measuring gas. The gas display and signal emission of the IR 22 is always proportional to the gas concentration.

## 2.4 Equipment configuration

### IR 22 without display

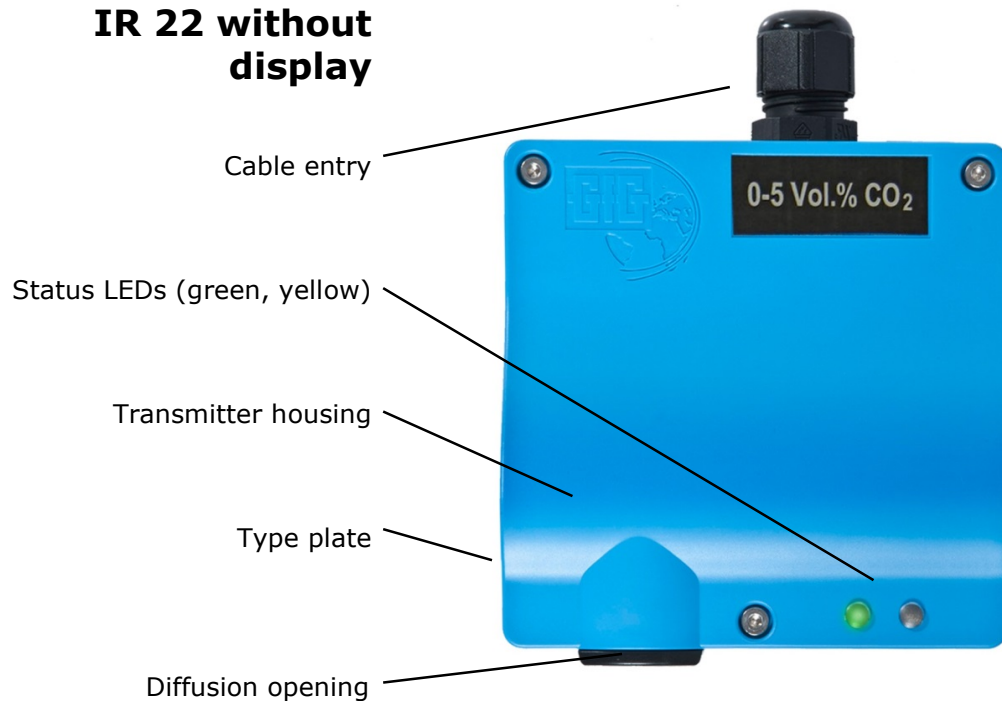

### IR 22 with display

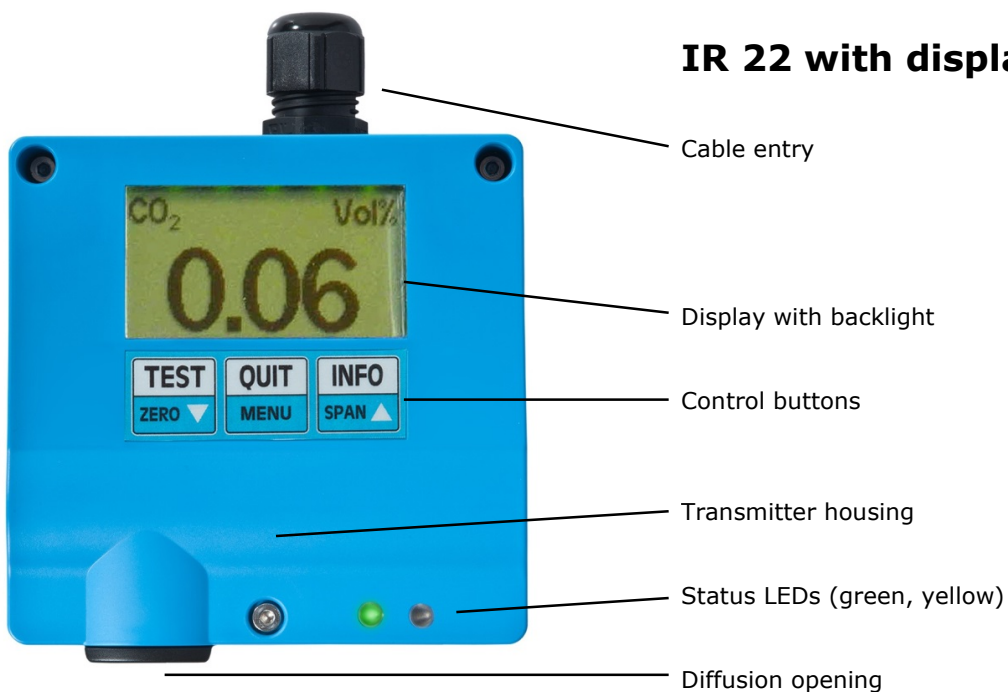

The gas sensor and the transmitter electronics are built into the transmitter housing. The electronics convert the measuring signal to a gas concentration and sends it with an analog current signal from 4-20mA or a digital RS485 bus signal in the Modbus RTU protocol. On the display model, gas concentrations and status information are also displayed.

The adjustment of the transmitter can be performed with the use of a multimeter, custom test leads (P/N 2220201) and two built-in potentiometers or, in the display version, through the display and the control keys.

## 3. ASSEMBLY AND INSTALLATION INSTRUCTIONS

### 3.1 Site of installation

When determining the transmitter installation location, it is important to know the environmental conditions and to take that into consideration for the mounting location. In order to be able to attain representative measuring results it is necessary to take the air flow conditions into consideration. Airflow analysis is recommended.

The transmitter needs to be installed in the room so that the gases pass across the sensor even in case of unfavorable ventilation. If necessary, an airflow study can be performed using small smoke tubes.

When determining the installation location, it is necessary to make sure that the transmitter is freely accessible for service and calibration.

Also observe external influences, such as:

- rain water, gushing water, drip water, condensate
- the dust content in the atmosphere

The transmitter is mostly protected against the penetration of water and dust. Under very difficult measuring conditions, a special accessory can protect the transmitter against damages. GfG will be glad to inform you about suitable additional measures that can be taken.



**If the sensor is exposed to environmental conditions which have not been known to GfG while planning or delivering the device, the warranty may be null and void.**

### 3.2 Assembly

When determining the installation location, it is necessary to make sure that the transmitter is freely accessible for service and calibration. The installation position of the transmitter has to be vertical with the sensor pointing downwards.

The transmitter will be connected to the analysis unit according to the connection plan. For the assembly, the three Allen screws need to be unscrewed and the housing cover needs to be removed. The circuit board is located in the housing. The terminals for the connection to the analysis unit are the upper part of the circuit board.

### 3.3 Installing electrical connections

The installation of the cable and the connection of the electrical source must only be performed by a specialist taking the relevant regulations into consideration. The core cross-section is dependent on the length of the connection wiring and the transmitter model. After installation, it is necessary to close and screw down the lid of the housing again.

For the analog data transmission, it is possible to use a cable with the core cross-section of 20 gauge for short distances of 545 yards. For long distance, the core cross-section should be 18 gauge.

#### Circuit diagram:

##### Terminals for the cable connection

- 1: Data- D0
- 2: Data+ D1 / 4-20mA / 0,2-1mA
- 3: 0V GND
- 4: 24V DC (12-30V DC)

##### Slide switch (Rt)

Terminating resistor for RS485  
(Factory setting =OFF)

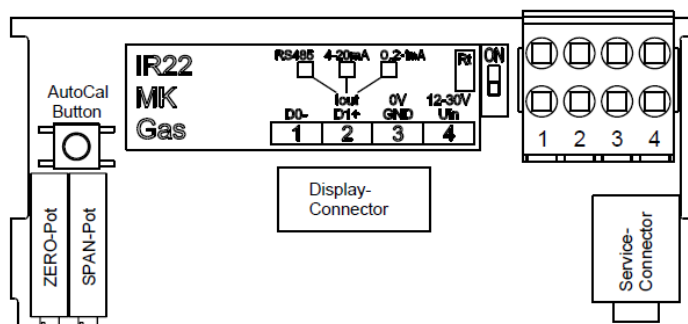

For digital data transfer via RS485 the bus cabling is dependent on various factors. This includes the composition of the bus as a strand or ring, the number of transmitters on the bus, the distance of the individual transmitters from the controller, the transmitter type / model, the sensor type, and the bus cable type. It is necessary to verify that the operating voltage is

sufficient for the bus model, in order to be able to sufficiently supply all the transmitters on the transmitter bus. If needed, the voltage supply may need to be extended by an additional voltage source. The cable length should not exceed 1,312 yards / 1200 meters.

In the following example, the maximum cable length for the installation of 8x IR 22 each in a distance of 33 ft / 10m is indicated at the end of the bus cable strand. In this example, IR 22 are devices without display and IR 22D are devices with display.



Sensor	IR 22	IR 22 D	Bus cable
Low Power (e.g. MK250, MK251 MK253, MK254)	850m	550m	2x2x0,5mm <sup>2</sup>
	1200m	1100m	2x2x1,0mm <sup>2</sup>
	1200m	1200m	2x2x1,5mm <sup>2</sup>

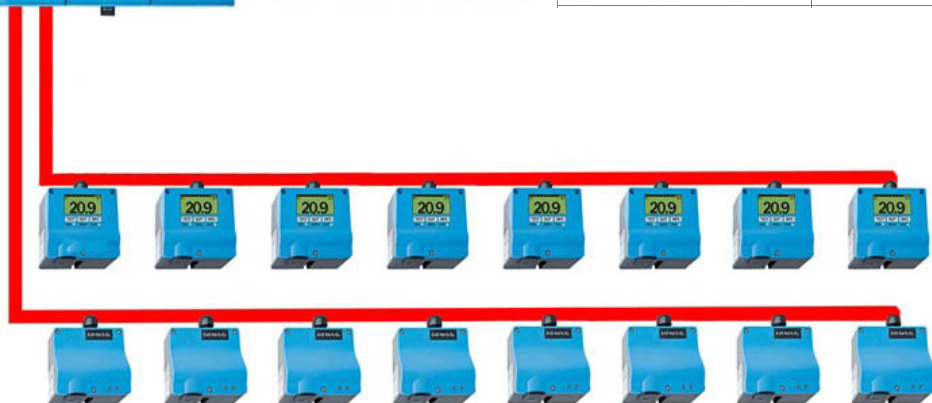

## 4. OPERATING INSTRUCTIONS

### 4.1 Commissioning

The function and display of the IR 22 transmitter are tested before shipping. The calibration is performed with corresponding test or calibration gases. However, there may be deviations depending on the transport, assembly and environmental conditions. Therefore, the gas warning system needs to be commissioned and tested by a qualified person.

After switching on, the transmitter needs a few minutes in order to:

- Perform the self-test at which the program and working memory is being checked
- Read and assess the device parameters with simultaneous memory scan
- Warm up the sensor

During the initial phase, the memory tests are run first.

Model with analog current interface (4-20mA):

Directly after the switching on, the current interface will emit 0.0mA and after 4 seconds it will emit 1.6mA. Then the green and red LEDs are illuminated.

Model with digital Modbus interface (RS485):

On the Modbus model, you can read "Startup" from the connected analysis unit e.g. GMA200.

First, the information about the *Firmware version* is displayed on the IR 22 display screen. Then, the measuring range, measuring unit, gas type and calibration gas concentration will be displayed. On the display, the remaining seconds of the start-up phase are counted down.



After the start-up phase of the sensor, the IR 22 automatically switches over to the measuring mode.

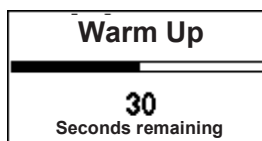
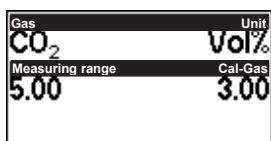

If a device error is detected during the start-up phase, the device will switch over to the malfunction mode.

Model with analog current interface (4-20mA):

The current interface will emit 1.2mA. An error message will be displayed (see displays of special statuses and malfunctions). The yellow malfunction LED is continuously illuminated.

Model with digital Modbus interface (RS485):

In the Modbus model, an error message is displayed on the display of the transmitter and / or the GMA (see displays of special statuses and malfunctions). The yellow malfunction LED is continuously illuminated.

Note:

The initial commissioning of the transmitter requires a verification as well as an adjustment of the zero point (ZERO) and subsequently also the sensitivity (SPAN) after the start-up time.

## 4.2 Measuring mode

During the trouble-free measuring mode, the green operating LED will be continuously illuminated, the yellow malfunction LED will be off. The functionality of the electronics will continuously be monitored by different tests, such as sensor, processor, and memory tests. The gas concentration is continuously measured and will be updated every second.

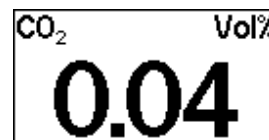
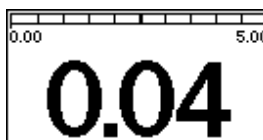

The digital display shows currently detected gas concentration during the measuring mode.



In the normal measuring mode, above the current gas concentration, a bar graph with a pre-set measuring range which is alternating every 5 seconds with the gas type and the gas unit will be displayed on the display screen of the transmitter during the measuring mode.

### 4.2.1 Exceeding the measuring range

If the measuring range is exceeded between 100% and 112% of the measuring range, it will be indicated by arrows ↑↑↑ which alternate with the measuring value.

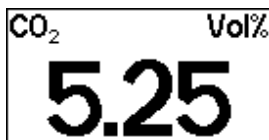
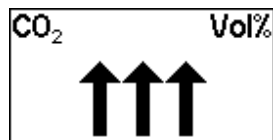

Transmitter with analog current interface 4-20mA:

The current interface will correspondingly emit a signal in the range from 20...22mA.

Transmitter with digital Modbus interface (RS485):

In the Modbus model, the corresponding measured value is displayed alternating with ↑↑↑ on the display of the transmitter and / or of the GMA (see displays of special statuses and malfunctions).

If the measuring range is exceeded more than 112% continuously represented arrows ↑↑↑ and a rapidly flashing yellow status LED will be displayed.



#### Transmitter with analog current interface 4-20mA:

The current interface will emit 22mA.

#### Transmitter with digital Modbus interface (RS485):

In the Modbus model ↑↑↑ are continuously displayed on the transmitter and / or on the GMA (see displays of special statuses and malfunctions).

### 4.2.2 Under range measuring signal

Measured values below the zero point will be displayed as numeric values with a negative sign. If the measured value is 0...-5% of the measuring range, the measured value will be displayed on the display screen of the transmitter or on the analysis unit (e.g. GMA 200).

If the measured value is -5...-7.5%, arrows ↓↓↓ alternating with the measured value are displayed.

If the measuring signal is greater than the measuring range of -7.5%, the arrows ↓↓↓ will be continuously displayed.

#### Transmitter with analog current interface 4-20mA:

The current interface will correspondingly emit a signal in the range from 2.8...4.0mA.

#### Transmitter with digital Modbus interface (RS485):

In the Modbus model, the corresponding measured value will be represented on the display of the transmitter and / or the GMA (see displays of special statuses and malfunctions).

### 4.2.3 Operating keys – Display models

With the operating keys of the transmitter    it is possible to perform sensor adjustments as well as settings on the menu.

### 4.2.4 Display, LED and horn test [TEST]

In the measuring mode it is possible to trigger a display and LED test by shortly pressing the test button  on transmitters with display.

With this, all LEDs will be triggered, all segments of the display are represented and in addition the status LEDs as well as an acoustic signal will be briefly triggered.

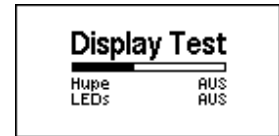

### 4.2.5 Display of operating parameters [INFO]

During the measuring mode, the following important operating parameters are automatically displayed one after another after briefly pressing the info button .

- Measuring gas
- Measuring unit
- Measuring range
- Calibration or test gas concentration

Gas	Unit
CO <sub>2</sub>	Vol%
Measuring range	Cal-Gas
5.00	3.00

These are also displayed during the start-up phase of the device.

### 4.2.6 Sensor service life

The service life of the infrared sensors mainly depends on the aging of the radiation source and from the changes of the optical surfaces on the sensor. Such changes can be caused by aggressive gases, by a dusty environment or by high humidity at strongly varying temperatures. Such sensor changes can be compensated to a certain extent. The service life to be expected of the sensors used in the IR 22 usually amounts to more than 5 years. A sensor needs to be replaced, if its signal quality has weakened where it can't be zeroed and / or calibrated.

## 4.3 Calibration and adjustment

### 4.3.1 Zero point calibration

For the calibration or adjustment of the zero point, it is necessary to distinguish between carbon dioxide sensor and other infrared sensors regarding the choice of the zero gas.

- Carbon dioxide sensors exclusively need to be calibrated or adjusted with 100% Vol. N<sub>2</sub>.
- For any other infrared sensor, it is also possible to use fresh air (.1 ppm THC) or in aggressive atmospheres, also synthetic air.

#### Calibration:

To do so, a calibration adapter will be used on the diffusion opening of the transmitter housing. Then the zero gas can be supplied pressure free to the sensor using the calibration adapter with a flow of 0.5 l/min. If the displayed value deviates from zero, it is possible to readjust the zero reading.

#### Adjusting the reading:

The adjusting of the zero point can be performed in different ways depending on the transmitter model. These options are described below.

### 4.3.2 Zero point adjustment with display and keyboard [ZERO]

In order to be able to perform the zero-point adjustment, it is necessary to enter the service code by pressing and holding the zero key  (>3 sec.). After having entered the standard service code "0011" (factory settings) the program "ZERO adjustment" will be activated. This will be shown by the flashing of the yellow status LED and for transmitters with analog interface (4-20mA) by an output signal of 2.4mA.

Then, the current gas measured value (display) and the pre-set zero gas concentration will be displayed. If the gas measured value is less than 10% of the measuring range, it is possible to start the zero point adjustment by pressing the left button [Start]. If the current gas measured value remains constant during a defined time interval, the new zero point will be accepted and displayed. The program "ZERO adjustment" will be terminated by pressing the right button and the system changes over to the measuring mode.

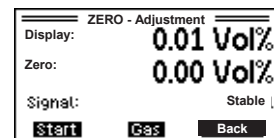
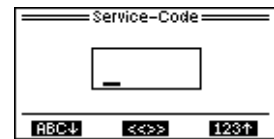

### 4.3.3 Zero point adjustment with the AutoCal button [ZERO]

For transmitters without display, the zero point adjustment can be easily performed by pressing the AutoCal button. In order to be able to press this button, it is necessary to remove the transmitter cover.

In order to prepare the adjustment, the AutoCal button needs to be pressed for at least 5 seconds.

During this first phase (0.-5.sec) the green status LED of 1Hz will flash and is illuminated by 50% each. If the button is released too soon during the first phase, it will not be adjusted and the measuring mode will continue normally.

After the first 5 seconds, the 1Hz flashing will change for another 5 seconds so that the green LED is shortly illuminated (10%). In order to start the zero point adjustment, the button needs to be released during this second phase (5.-10.sec). Then the adjustment process will be indicated by a flashing yellow status LED and a current output signal of 2.0mA. If the measured value remains constant during the defined time interval, the new zero point will be accepted and the measured value will be set to 0.00% Vol. A successful adjustment will be indicated by rapid flashing of the green LED; however, if the adjustment failed, it will be indicated by rapid flashing of the yellow LED. Then, the adjustment process will be automatically terminated.

If the button is pressed for more than 15 seconds, it will not be adjusted and the measuring mode will continue normally.

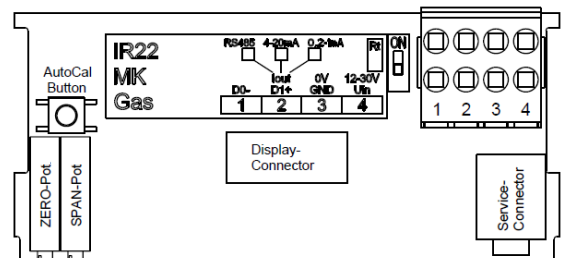

### 4.3.4 Zero point adjustment with the ZERO-Pot

For transmitters without display, the zero point adjustment can be performed with the cover removed. The ZERO-Pot can be adjusted with a small screw driver, a multimeter, and with the custom test cables (see paragraph "Accessories and spare parts"). The custom test cable must be plugged into the voltage measuring sockets of the multimeter and the service plug must be plugged in the service connector of the transmitter.

As long as the ZERO-Pot is not being turned, it is possible to read a voltage value of 0.2-1V DC from the multimeter, which proportionally corresponds to the current gas measuring value in the range from 0-100% of the measuring range.

As soon as the ZERO-Pot is turned, it is possible to read the set point for the zero point adjustment from the multimeter. This will be indicated by the flashing of the yellow status LED. It is necessary to turn until the voltage value of 0.200V is displayed. As soon as this set point remains unchanged for a longer period of time, the zero point adjustment will be started by the transmitter. The yellow status LED goes out as soon as the adjustment process has been completed.

The zero point adjustment for the display values of up to 25% can be performed with the ZERO-Pot. If the transmitter jumps back to the initial (not adjusted) measured value after having performed the adjustment process, in spite of the correct supply of the calibration gas, it was probably not possible to perform the adjustment successfully due to exceeding the tolerable signal limits or an increased signal noise. This may indicate that the sensor is defective and thus needs to be replaced as soon as possible.

### 4.3.5 Sensitivity calibration



**When handling toxic gases, it is necessary to follow special instructions for behaviour depending on the test gas used. Please find further information in the corresponding Safety Data Sheets.**

For the calibration or adjustment of the gas sensitivity, a calibration adapter needs to be connected to the diffusion opening of the transmitter housing. The test or calibration gas will be supplied pressure free with a volume flow of about 0.5 l<sub>min</sub> to the sensor via the calibration adapter.

Note the display value on the display screen. If the display value deviates from the calibration gas concentration, a sensitivity adjustment is necessary.

#### Adjusting the display:

Before each adjustment of the sensitivity, the zero point should be verified and readjusted, if required. The adjustment of the sensitivity can be performed in different ways depending on the transmitter model. Both options are described below.

### 4.3.6 Sensitivity adjustment with display and keyboard [SPAN]

In order to be able to perform the sensitivity adjustment, it is necessary to enter the service code prompt by pressing and holding the span key ( $>3$  sec.). After having entered the standard service code "0011" the program "SPAN adjustment" will be activated. This will be indicated by the flashing of the yellow status LED and for transmitters with analog interface (4-20mA) by an output signal of 2.4mA.

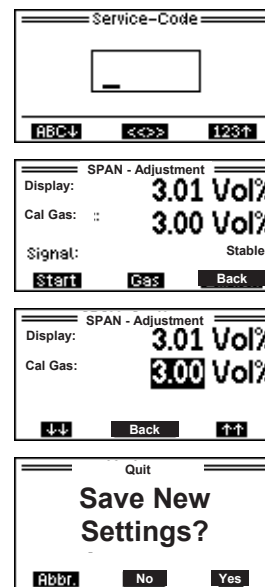

Then, the current gas measured value (display) and the pre-set test gas concentration (Cal-gas) will be displayed. After having pressed the center button [gas] it is possible to change the concentration of the test gas by pressing the left or right button and the changed value can be saved by pressing the center button.

If the gas measured value amounts to a minimum 7% of the measuring range, it is possible to start the sensitivity adjustment by pressing the left button [Start]. As soon as a stable measured value has been collected within a defined time interval, the sensitivity will be adjusted and the new measured value is displayed. The program "SPAN adjustment" will be terminated by pressing the right button and thus the system changes back to the measuring mode.

### 4.3.7 Sensitivity adjustment with the AutoCal button [SPAN]

For transmitters without display, if the test gas concentration which is set in the transmitter is known and a test gas with this concentration is present, then it is possible to perform the sensitivity adjustment by pressing the AutoCal button.

In order to press this button, it is necessary to remove the transmitter cover.

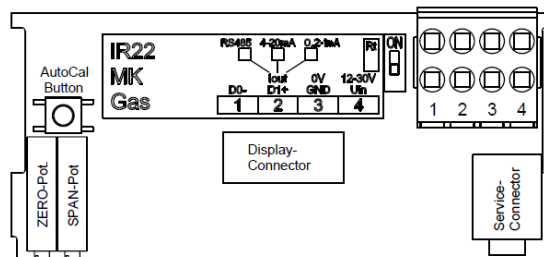

In order to start the adjustment, the AutoCal button needs to be pressed for at least 10 seconds. During a first phase (0.-5.sec) the green status LED flashes with 1Hz and it is illuminated with up to 50%. If the button is released early during the first phase it will not be adjusted and the measuring mode will be continued normally. After the first phase, a second phase (5.-10.sec) will follow, during which the flashing changes in a way, that the green LED is only briefly illuminated (10%). If the button is released during this second phase, then, the zero point adjustment will be started. In particular for CO<sub>2</sub> transmitters, the zero point would be misadjusted if no corresponding zero gas is used.

However, in order to start the sensitivity adjustment, the button must only be released during the third phase (10.-15.sec). In this case, the 1Hz flashing of the green LED changes in a way that the LED is illuminated considerably longer (90%). Then the adjustment process will be indicated by flashing of the yellow status LED and a current output signal of 2.0mA. If the measured value remains constant during a defined time interval, the sensitivity will be adjusted in a way that the measured value displays the pre-set test gas concentration. A successful adjustment will be indicated by rapid flashing of the green LED; however, if the adjustment failed, it will be indicated by rapid flashing of the yellow LED. Now, it is necessary to remove the test gas. Then, the adjustment process will be automatically terminated.

If the button is pressed even longer than 15 seconds, it will not be adjusted and the measuring mode will continue normally.

### 4.3.8 Sensitivity adjustment with the SPAN-Pot

For transmitters without display, the sensitivity adjustment with the transmitter cover off the SPAN-Pot can be performed with the help of a small screw driver, a multimeter and with the custom test cable with service plug (see paragraph "Accessories and spare parts"). The test cable must be plugged into the voltage measuring sockets of the multimeter and the service plug must be plugged in the service connector of the transmitter.

As long as the SPAN-Pot is not being turned, it is possible to read a voltage value of 0.2-1V DC from the multimeter, which proportionally corresponds to the current gas measuring value in the range from 0-100% of the measuring range.

As soon as the SPAN-Pot has been turned, it is possible to read the set point for the sensitivity adjustment from the multimeter. This will be indicated by the flashing of the yellow status LED. It is necessary to turn until the voltage value of e.g. 0.600V (for 50% measuring range) is displayed. As soon as this set point remains unchanged for a period of time, the sensitivity adjustment will be started by the transmitter. The yellow status LED goes out as soon as the adjustment process is completed.

If the transmitter jumps back to the initial value (not adjusted) after having performed the adjustment process, in spite of the correct supply of the calibration gas, it is probably not possible to perform the adjustment successfully due to exceeding the tolerable signal limits or increased signal noise. This may indicate that the sensor is defective and thus needs to be replaced as soon as possible.

## 4.4 Main and service menu [MENU]

In order to change over to the main menu and then from there to the service menu, it is necessary to press the center button [MENU] for at least 3 seconds. The access to the main menu is not protected by an access code.

### 4.4.1 Main menu

In the main menu itself and when changing to the individual menu items, the transmitter will be in the measuring mode. i.e. The collection and processing of the measuring values and the signal output in the background. However, there is an exception on the service menu which is described in the following paragraph. The main menu is structured as follows:

- Transmitter status
- Transmitter information
- Service menu
- Quit

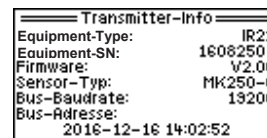
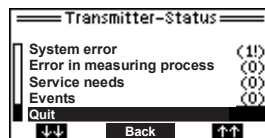

It is possible to view the current system errors, errors in the measuring process, service requirements, and events in the transmitter status. Behind these groups there are numbers in brackets. These numbers indicate the number of the existing events.

### 4.4.2 Service menu

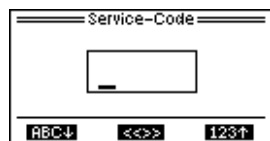

In order to open up the service menu, a special access code needs to be entered. For the standard service menu, the code is "1100". In an extended service menu, additional functions are also available. The access to this extended service menu is only reserved for the GfG service staff.

The service menu is subdivided as follows:

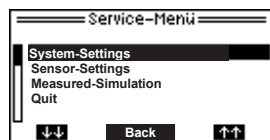

**System settings:** Here you will find the general setting options for the RS485 bus interface or the analog interface, the language, the display contrast, the tolerance band and the horn.

**Sensor settings:** Here you will find the settings which are necessary for the sensor change as well as the selection of the measuring range.

**Measured value simulation:** Here it is possible to generate measured values without test gas in order to check the output signal of the interface and the downstream signal processing.

In the following subsections, these settings are described in detail.



#### 4.4.2.1 System settings

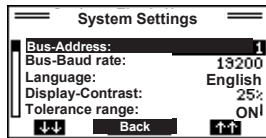

If there is an RS485 bus interface on the transmitter, the **bus address** can be set in a range from 1 to 247 (0=inactive). This bus address must only be used once in the same bus segment.

The **bus baud rate** can be set to 9600, 19200 or 38400 bauds. It is set to 19200 bauds by default. For very long bus lines, the baud rate can be reduced to 9600 bauds and for a lot of bus participants it can be increased to 38400 bauds. In the same bus segment, the baud rate always needs to be the same for all bus participants.

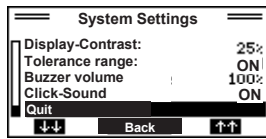

The **language** can be set to German or English and is relevant for all display outputs, in particular for the menus.

The **display contrast** can be set from 0 to 100%. This value can vary from one display to another and is generally set to 25...40%.

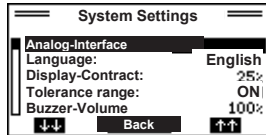

The **tolerance band** can be "ON" or "OFF". In the setting "ON" (default) little signal deviations from the zero gas are displayed as 0% Vol or 0 %LEL. The real measured value will only be displayed when the tolerance band is exceeded or undercut. In the setting "OFF", the real measured value is displayed.

The **buzzer volume** can be set from 0 to 100%.

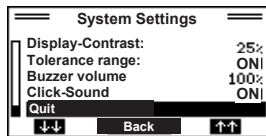

The **click sound** can be switched "ON" or "OFF". In the setting "ON" (default) the internal buzzer generates a short click sound for each actuation of a key.

If the transmitter is equipped with an analog 4-20mA interface, then the current interfaces can be adjusted and tested in the extended service menu under **analog interface**.

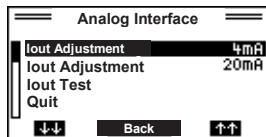

**Iout adjustment:** Caution !!! The adjustment of the current interface must only be performed with a very accurate current measurement device.

**Iout Test:** Here, the current output can be tested in the range from 0.5 to 24.5mA.

#### 4.4.2.2 Sensor settings

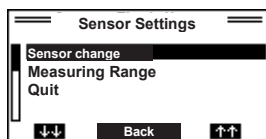

Only in the extended service menu, the following settings concerning the sensor are possible:

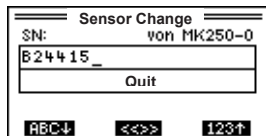

**Sensor replacement:** If the gas sensor is used up and needs to be replaced by a new sensor of the same type (MK...), then it is necessary to enter the new sensor under this menu item. After having completed the entry, the calibration data of the old sensor will be deleted and replaced by default values. The zero point and the gas sensitivity of the new gas sensor needs to be adjusted in any case.

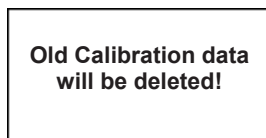

**Measuring range:** GfG will deliver the transmitter configured with the measuring range desired by the customer. However, if another measuring range is required subsequently and if other measuring ranges are available for the sensor, then it is possible to select another measurement range under this menu item.

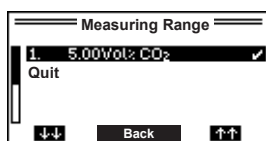

Due to large differences in the measuring range and other types of gas, the calibration data of the current measuring range will not be taken over. i.e., if another measurement range or another type of gas is selected, it is necessary to readjust the zero point and the gas sensitivity.

### 4.4.2.3 Measured value simulation

With the help of the simulation of the measured value, the output signal, the transmission of the measured value, and the downstream signal processing can be checked. This makes it possible to generate time-limited measuring value, when there is no corresponding test gas available.

Initially, the current measured value will still be displayed. The simulation mode will only be started after having pressed the left or right button. Above the keyboard labelling, the maximum remaining simulation time will be displayed. If the simulation value has been modified with the left or right button, the remaining simulation time will be set to 5 minutes. It is possible to stop the simulation mode by pressing the center button. If no button is pressed, the simulation mode will be terminated at the end of the remaining simulation time and the system automatically changes over to the measuring mode.

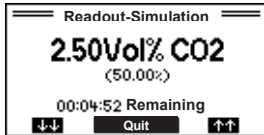

## 4.5 Displays and messages

### 4.5.1 Overview of the status LED conditions and current output signals

In the following table the different display statuses of the two status LEDs and the current output signals are listed with a reference to their meaning.

Green LED	Yellow LED	Current output	For description, refer to paragraph ...
Off	Flashes with 1Hz	0.0mA	Display of special statuses ... No. 001
Off	On	0.0mA	Display of special statuses ... No. 002
Off	On	1.2mA	Display of special statuses ... No. 102...113
Single pulse every 5s	On	1.2mA	Display of special statuses ... No. 101
Flashes with 1Hz	On	1.6mA	Display of special statuses ... No. 002, 003
On	Flashes with 1Hz	2.0mA	Displays in the service mode ... No. 204, 205
On	Flashes with 1Hz	2.4mA	Displays in the service mode ... No. 203
On	Flashes with 1Hz	4-20mA	Displays in the service mode ... No. 201, 202
On	Single pulse every 5s	2.8-22mA	Displays in the measuring mode ... No. 309, 310
On	On	2.8mA	Displays in the measuring mode ... No. 307
On	Off	2.8-22mA	Displays in the measuring mode ... No. 303...306
On	Flashes with 5Hz	22mA	Displays in the measuring mode ... No. 301, 302

### 4.5.2 Displays of special statuses (device start and malfunction)

The statuses are described in the following table, where the yellow fault LED is continuously illuminated and the current 4-20mA current output emits a signal  $\leq 1.6\text{mA}$ .

#### Behavior while starting the device:

No.	Screen display	Green LED	Yellow LED	Current output	Cause	Note / Explanation
001	Boot V1.12 GfG IR 22 Error:Flash	Off	Flashes with 1Hz	0.0mA	An error in the program memory was determined while testing the memory.	Restart the transmitter. In case of another error message, a Firmware update is required.
002	Boot V1.12 GfG IR 22 Verify	Off	On	0.0mA	Program and memory tests during the first seconds of the device start	after about 4 seconds, automatic transfer to the initialization phase
003	V2.02 GfG IR 22	Flashes with 1Hz	On	1.6mA (0,08mA)	Initialization phase of the transmitter	after about 3 seconds, automatic transfer to the sensor inlet phase
004	Heating up XX seconds remaining	Flashes with 1Hz	On	1.6mA (0,08mA)	Sensor inlet phase	After the expiry of the time period, automatic transfer to the measuring mode



### Behavior in case of a malfunction:

No.	Screen display	Green LED	Yellow LED	Current output	Cause	Note /Explanation
101	Sensor defective	Single pulse every 5s	On	1.2mA (0,06mA)	The sensor does not react correctly on the gas. Possibly, the sensor is too old.	The sensor needs to be replaced
102	Supply voltage wrong	Off	On	1.2mA (0,06mA)	The supply voltage of the transmitter is too low or too high.	Check and readjust the voltage supply
103	Temp.signal < MIN Temp.signal > MAX	Off	On	1.2mA (0,06mA)	The temperature measurement is possibly incorrect.	
104	Watchdog error	Off	On	1.2mA (0,06mA)	When testing the external watchdog, a hardware error was determined.	Restart the device Replace the device in case of another error message.
105	FLASH error	Off	On	1.2mA (0,06mA)	An error in the program memory was determined while testing the memory.	
106	RAM error	Off	On	1.2mA (0,06mA)	An incorrect RAM was determined while testing the memory.	
107	EEPROM error 1 EEPROM error 2 EEPROM error 2c EEPROM error 1+2 EEPROM error 1<>2	Off	On	1.2mA (0,06mA)	Error in the parameter memory or when accessing the ext. Parameter memory component.	
108	Wrong PCB type	Off	On	1.2mA (0,06mA)	A wrong type of circuit board an error of the circuit board was determined.	Restart the device Replace the device in case of another error message.
109	Digipot error	Off	On	1.2mA (0,06mA)	A hardware error was detected on the digital potentiometer.	
110	ADC error 1 ADC error 2	Off	On	1.2mA (0,06mA)	An error was determined on the analog / digital converter.	
111	Error in the program sequence	Off	On	1.2mA (0,06mA)	A logical sequence error was determined during the program processing.	
112	Malfunction sensor Ik	Off	On	1.2mA (0,06mA)	The supply voltage of the transmitter is too low / too high.	Have the sensor and the electronics checked and replaced by the GfG Service, if required
113	Permanent ↓↓↓	Off	On	1.2mA (0,06mA)	The measuring signal undercut the measuring range of the transmitter electronics	

### 4.5.3 Displays in the service mode and for the sensor adjustment

The statuses are described in the following table, where the green operation LED is continuously illuminated and the current 4-20mA current output emits a signal of 2.0...2.4mA.

No.	Screen display	Green LED	Yellow LED	Current output	Cause	Note /Explanation
201	Adjustment zero point (ZERO-Pot)	On	Flashes with 1Hz	4-20mA (0,2-1mA)	The AutoCal program for the zero point adjustment was activated with the ZERO-Pot	The zero-gas setting is performed with the ZERO-Pot
202	Adjustment sensitivity (SPAN-Pot)	On	Flashes with 1Hz	4-20mA (0,2-1mA)	The AutoCal program for the sensitivity adjustment was activated with the SPAN-Pot	The calibration gas setting is performed with the SPAN-Pot
203	Menu item	On	Flashes with 1Hz	2.4mA (0,12mA)	The service menu was activated via the keyboard	Select the menu item If no entry is made for a minute, the system automatically returns to the measuring mode
204	Adjustment zero point	On	Flashes with 1Hz	2.0mA (0,10mA)	Zero point adjustment was activated via the keyboard	AutoCal adjustment of the zero point
205	Adjustment sensitivity	On	Flashes with 1Hz	2.0mA (0,10mA)	Sensitivity adjustment was activated via the keyboard	AutoCal adjustment of the sensitivity

#### 4.5.4 Displays in the measuring mode

The statuses are described in the following table, where the green operation LED is continuously illuminated and the current 4-20mA current output emits a signal of 2.8...22mA.

No.	Screen display	Green LED	Yellow LED	Current output	Cause	Note /Explanation
301	↑↑↑ permanent	On	Flashes with 5Hz	22mA	The gas concentration exceeded the transmitter electronics.	
302	↑↑↑ permanent	On	Flashes with 5Hz	22mA	The gas concentration considerably exceeded the measuring range (gas ≥ 112,5%MB)	
303	↑↑↑ alternating with the measured value	On	Off	20-22mA	The gas concentration considerably exceeded the measuring range (100...112%MB)	
304	Measured value	On	Off	4-20mA	Trouble-free measuring operation	
305	Measured value	On	Off	3.2-4mA	Undercutting the measuring range (-5.0...0.0%MB)	
306	Measured value alternating with ↓↓↓	On	Off	2.8-3.2mA	Undercutting the measuring range (-7.5...-5.0%MB)	Zero-point adjustment is reasonable
307	Permanent ↓↓↓	On	On	2.8mA	Undercutting the measuring range (less than -7.5%MB)	Zero-point adjustment is required
309	<i>Sensor replacement &lt;1 month</i>	On	Single pulse every 5s	2.8-22mA	Expected operating time of the sensor will be attained soon.	Sensor replacement or adjustment will be required
310	<i>Sensor replacement required</i>	On	Single pulse every 5s	2.8-22mA	Expected operating time of the sensor has been exceeded.	Sensor replacement or adjustment is required

#### 4.5.5 Priority of displays and messages in the measuring mode

The displays of statuses of lower priority will be overwritten by displays of higher priority. The statuses of lower priority will not be reset.

Priority	Status	For description, refer to paragraph ...
	Clear exceeding of the measuring range	Displays in the measuring mode ... No. 301, 302
	Slight exceeding of the measuring range	Displays in the measuring mode No. 303
	Under range measuring signal	Displays in the measuring mode No. 305...307
	Sensor replacement	Displays in the measuring mode No. 309, 310

The sensor error No. 101 and the transmitter malfunction No. 102...113 suspend the measuring mode with their corresponding messages.

#### 4.6 Malfunction, cause, remedy

Malfunction	Cause	Remedy
The zero point can no longer be set	Sensor defective	Replace sensor
The sensitivity can no longer be set	Sensor defective	Replace sensor
The output current has decreased to 0mA	Fuse or electronics defective	Replace the circuit board
	Line interrupted	Re-establish connection

## **5. APPENDIX**

### **5.1 Cleaning and care**

External soiling of the transmitter housing can be removed using a cloth dampened with water. Do not use solvents or cleaning agents!

### **5.2 Maintenance and service**

Maintenance and service include regular visual inspections, functional testing, and system checks as well as repairs to the gas warning system.

#### **5.2.1 Visual inspection**

Visual inspections should be carried out on a regular basis with a maximum interval of one month and include the following tasks:

- Check the operation display and the status messages, e.g. operation display "On", alarm and fault displays "Off"
- Check for mechanical damage and external soiling

## 5.2.2 Functional testing

Functional testing can be carried out at specific intervals, which depend on the gas hazard being monitored. The intervals between the controls should not exceed 6 months.

It includes the following tasks:

- Visual inspection according to section 5.2.1 of these operating instructions
- Testing and evaluation of the measured value displays
- Triggering the alarm thresholds
- Triggering the test functions for display elements as well as optical and acoustic signal transducers, without triggering switching functions
- Inspection of saved messages, faults and maintenance requirements

## 5.2.3 System check

The system check must be carried out at regular intervals. The time between intervals should not exceed 1 year. It includes the following tasks:

- Functional control according to section 5.2.2 of these operating instructions
- Inspection of all safety functions, including triggering of switching functions
- Monitoring of parameterization via target / actual comparison
- Inspection of signalling and registration modules

## 5.2.4 Repair

This includes all repair and replacement tasks. These tasks should only be carried out by the manufacturer and persons who have been authorized to do so by the manufacturer, GfG Instrumentation. Only original spare parts and original modules inspected and approved by the manufacturer should be used.

## 5.3 Sensor replacement

It is necessary to remove the transmitter cover in order to replace the sensor. At zero voltage, the electronics with the sensor can be pulled out of the guiding. Then, it is possible to pull off the old sensor and to plug in the new sensor. The remaining assembly work is performed in reverse order. It is only allowable to use a sensor of the same type as a replacement sensor, its serial number has to be entered in the service menu of the transmitter after the installation.

## 5.4 Accessories and spare parts

	Description	Order No
1.	Calibration adapter for EC 22 and IR 22	2220-200
2.	Test cable with service plug for EC 22, CC 22, ZD 22, CS 22 and IR 22	2220201
3.	Replacement sensors for IR 22	Upon request

## 5.5 Sensor specification

<b>MK250-0 Infrared sensor for carbon dioxide CO<sub>2</sub></b>			
Measuring range:		0.00...5.00Vol.%	
Resolution / tolerance band:		0.01% Vol. / ±0.00% Vol.	
Setting time:		t <sub>50</sub> < 25sec    t <sub>90</sub> < 50sec    t <sub>10</sub> ≤ 50sec	
Pressure	70...130kPa:	<1.6% of the display per 1% pressure change	(concerning 100kPa)
Humidity	0%...95% RH:	max. ±0.01% Vol. or ±2% of the display	(concerning 50% r.h. @68°F / 20°C)
Temperature	-13°F... 122°F:	max. ±0.02% Vol. or ±10(15)% of the display	(concerning 68°F / 20°C)
Long term stability	per month:	max. ±0.01% Vol. or ±2% of the display	(under laboratory conditions)
Expected service life:		> 5 years	
<b>MK251-0 Infrared sensor for carbon dioxide CO<sub>2</sub></b>			
Measuring range:		0.000...1.000% Vol. or 0...10000 ppm CO <sub>2</sub>	
Resolution:		0.001% Vol. or 10 ppm	
Tolerance band:		±0.000% Vol. or 0 ppm	
Setting time:		t <sub>50</sub> < 25sec    t <sub>90</sub> < 50sec    t <sub>10</sub> ≤ 50sec	
Pressure	70...130kPa:	<1.6% of the display per 1% pressure change	(concerning 100kPa)
Humidity	0%...95% RH:	max. ±0.010% Vol. or ±2% of the display	(concerning 50% r.h. @68°F / 20°C)
Temperature	-13°F... 122°F:	max. ±0.020% Vol. or ±10(15)% of the display	(concerning 68°F / 20°C)
Long term stability	per month:	max. ±0.010% Vol. or ±2% of the display	(under laboratory conditions)
Expected service life:		> 5 years	
<b>MK252-0 Infrared sensor for carbon dioxide CO<sub>2</sub></b>			
Measuring range:		0.000...25.0% Vol. or 0.0...50.0% Vol.	
Resolution:		0.1% Vol.	
Tolerance band:		±0.000% Vol.	
Setting time:		t <sub>50</sub> < 25sec    t <sub>90</sub> < 50sec    t <sub>10</sub> ≤ 50sec	
Pressure	70...130kPa:	<1.6% of the display per 1% pressure change	(concerning 100kPa)
Humidity		0%...95% RH, non-condensing	
Temperature	-13°F... 122°F:	max. ±0.5% by volume or max. ±1% Vol. or ±10% of the display or ±15% of the display	(concerning 68°F / 20°C)
Expected service life:		> 5 years	
<b>MK253-0 Infrared sensor for propane C<sub>3</sub>H<sub>8</sub></b>			
Measuring range:		0.0...100.0% LEL or 0.00...2.00% Vol. C <sub>3</sub> H <sub>8</sub>	
Resolution:		0.2% LEL or 0.01% Vol.	
Tolerance band:		±1.0% LEL or ±0.02% Vol.	
Setting time:		t <sub>50</sub> < 25sec    t <sub>90</sub> < 50sec	
Pressure	70...130kPa:	<1.2% of the display per 1% pressure change	(concerning 100kPa)
Humidity	0%...95% RH:	max. ±2.0% LEL or ±15% of the display	(concerning 0% r.h. @104°F / 40°C)
Temperature	-13°F... 122°F:	max. ±2.0% LEL or ±10(15)% of the display	(concerning 68°F / 20°C)
Expected service life:		> 5 years	
<b>MK254-0 Infrared sensor for methane CH<sub>4</sub></b>			
Measuring range:		0.0...100.0% LEL or 0.00...5.00% Vol. CH <sub>4</sub>	
Resolution:		0.2% LEL or 0.01% Vol.	
Tolerance band:		±1.0% LEL or ±0.05% Vol.	
Setting time:		t <sub>50</sub> < 25sec    t <sub>90</sub> < 50sec	
Pressure	70...130kPa:	<1.5% of the display per 1% pressure change	(concerning 100kPa)
Humidity	0%...95% RH:	max. ±2.0% LEL or ±15% of the display	(concerning 0%r.h. @104°F \ 40°C)
Temperature	-13°F... 122°F:	max. ±2.0% LEL or ±10(15)% of the display	(concerning 68°F / 20°C)
Cross sensitivities	@ 50% LEL:	1.20% Vol. C <sub>2</sub> H <sub>6</sub> → >125% LEL (5.5% Vol.) 0.55% Vol. C <sub>3</sub> H <sub>12</sub> → about 55% LEL (2.5% Vol.) 0.85% Vol. C <sub>3</sub> H <sub>8</sub> → about 90% LEL (4.0% Vol.) 2.20% Vol. CH <sub>4</sub> → = 50% LEL 1.55% Vol. C <sub>2</sub> H <sub>6</sub> O → about 80% LEL (3.5% Vol.) 0.50% Vol. C <sub>6</sub> H <sub>14</sub> → about 45% LEL (2.0% Vol.) 0.70% Vol. C <sub>4</sub> H <sub>10</sub> → about 65% LEL (2.9% Vol.) 1.15% Vol. C <sub>2</sub> H <sub>4</sub> → about 20% LEL (0.9% Vol.)	
Expected service life:		They may vary from one sensor to another and depend on the gas concentration. > 5 years	

## 5.6 Technical data

<b>Type designation:</b>	<b>IR 22</b>
<b>Ambient conditions</b> Operating temperature: Storage temperature: Humidity: Air pressure:	-13°...122°F (-25...+50°C ) 32° ...140° F (0...+60°C ) 0...95%r.h. 70...130kPa (depending on the sensor)
<b>Power supply</b> Operating voltage: Current consumption without display: with display: with display+horn: Fuses:	24V DC (12-30V DC admissible) <u>For RS485 version</u> typ. 15/18/21mA @24V/18V/12V typ. 20/25/33mA @24V/18V/12V max.30/38/50mA @24V/18V/12V 250mA (not replaceable) <u>4-20mA version</u> max.37/40/43mA @24V/18V/12V max.42/47/55mA @24V/18V/12V max.52/60/72mA @24V/18V/12V
<b>Sensors</b> Measuring range and measuring gas: Measuring gas supply:	Depending on the sensor Diffusion
<b>Display &amp; control elements</b> Status LEDs: Display, keys: Potentiometer:	Green for operation and yellow for malfunction or service 2.2" graphic display and 3 functional keys (for the display version) For ZERO and SPAN adjustment (optionally)
<b>Service connector</b> Construction: Analog output: Digital input:	3.5mm stereo jack socket (inboard) 0.2...1.0V corresponding to 0...100% measuring range for sensor calibration For configuration and Firmware update
<b>Signal output</b> analog: or digital:	4...20mA (max. resistance: 150Ω/400Ω/650Ω @12V/18V/24V supply) RS485; half duplex; 9600/19200/38400 baud; Modbus protocol, slide switch for 120Ω terminating resistor
<b>Connection cables</b> Cable glands: Connection terminals: Cable (analog): Cable (digital):	1 or 2 pieces M16x1.5 (for cable diameter 4.5-10mm) 4 pieces (for 0.08...2.5mm <sup>2</sup> conductor cross-section) 3-wire e.g. LiYY 3x0.34...0.75mm <sup>2</sup> or LiYCY 4-wire e.g. LiYY 4x0.75...1.5mm <sup>2</sup> or bus line Y(St)Y 2x2x0.8
<b>Housing</b> Protection class: Material: Dimensions: Weight:	IP54 according to IEC 60529 Plastic 4 x 5 x 2 in. (WxHxD) with sensor 4.5...5.3 oz or 6...7 oz (for display model)
<b>Approvals</b> Electromagnetic compatibility: CSA:	DIN EN 50270:2015 Emitted interference: Type class I Interference resistance: Type class II CAN/CSA-C22.2 No. 61010-1-12 + Amd 1 - 18 UL 61010-1 (2012)

## 5.7 Declaration of Conformity

### EU Declaration of Conformity

### GfG Gesellschaft für Gerätebau mbH

#### Transmitter IR22

Klönnestraße 99  
44143 Dortmund  
Tel: +49 (231) 56400-0  
Fax: +49 (231) 516313  
E-Mail: info@gfg-mbh.com  
www.gfg.biz

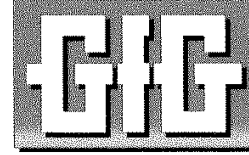

Edited: 01.03.2017 Amended: 31.07.2017

GfG Gesellschaft für Gerätebau mbH develops produces and sells gas sensors and gas warning devices which are subject to a **quality management system** as per DIN EN ISO 9001.

Subject to supervision by means of a **quality system**, surveilled by the notified body, DEKRA EXAM GmbH (0158), is the production of electrical apparatus of instrumentation Group I and II, categories M1, M2, 1G and 2G for gas sensors, gas detectors, gas warning systems in types of protection flameproof enclosures, increased safety, encapsulation and intrinsic safety, as well as their measuring function.

The Transmitter **IR22** complies with council directive **2014/30/EU** for electromagnetic compatibility and with directive **2011/65/EU** (RoHS) on the restriction of the use of certain hazardous substances in electrical and electronic equipment.

The directive 2014/30/EU is complied considering the following standard:

- Electromagnetic compatibility - Electrical apparatus for the detection and measurement of combustible gases, toxic gases or oxygen EN 50270: 2015
- Radio shielding Type class 1
- Interference resistance Type class 2

The EMC test laboratory EM TEST GmbH at Kamen has tested and certified the electromagnetic compatibility.

The directive 2011/65/EU is complied considering the following standard:

- Technical documentation for the assessment of electrical and electronic products with respect to the restriction of hazardous substances EN 50581 : 2012

Dortmund, 14 September 2017

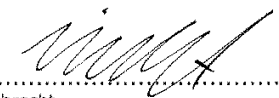
i.v.   
.....

B. Siebrecht  
QMB

## **GfG Instrumentation, Inc.**

1194 Oak Valley Dr.  
Suite 20  
Ann Arbor, MI 48108  
USA

US/Canada: (800) 959-0329  
US/Canada Fax: (734) 769-1888  
International: +1 734 769 0573  
International Fax: +1 734 769 1888  
E-mail: [info@goodforgas.com](mailto:info@goodforgas.com)  
Website: [www.goodforgas.com](http://www.goodforgas.com)



# **GfG Instrumentation**

Worldwide Manufacturer of Gas Detection Solutions

7004-032 Rev. 4 (06/16/20)